

Hardware Locality (hwloc)

1.3.3

Generated by Doxygen 1.8.3.1

Sun Feb 24 2013 15:44:20

Contents

1	Hardware Locality	1
1.1	Introduction	1
1.2	Installation	2
1.3	CLI Examples	3
1.4	Programming Interface	8
1.4.1	Portability	9
1.4.2	API Example	12
1.5	Questions and Bugs	15
1.6	History / Credits	15
1.7	Further Reading	15
2	Terms and Definitions	17
3	Command-Line Tools	21
3.1	lstopo	21
3.2	hwloc-bind	21
3.3	hwloc-calc	21
3.4	hwloc-distrib	22
3.5	hwloc-ps	22
3.6	hwloc-gather-topology	22
4	Environment Variables	23
5	CPU and Memory Binding Overview	25
6	I/O Devices	27
6.1	Enabling and requirements	27
6.2	I/O object hierarchy	27
6.3	Software devices	28
6.4	Consulting I/O devices and binding	28

6.5	Examples	28
7	Importing and exporting topologies from/to XML files	31
7.1	libxml2 and minimalistic XML backends	31
7.2	XML import error management	31
8	Interoperability With Other Software	33
9	Thread Safety	35
10	Embedding hwloc in Other Software	37
10.1	Using hwloc's M4 Embedding Capabilities	37
10.2	Example Embedding hwloc	39
11	Frequently Asked Questions	41
11.1	I do not want hwloc to rediscover my enormous machine topology every time I rerun a process	41
11.2	Does hwloc require privileged access?	41
11.3	hwloc only has a one-dimensional view of the architecture, it ignores distances	41
11.4	How may I ignore symmetric multithreading, hyper-threading, ... ?	42
11.5	What happens if my topology is asymmetric?	42
11.6	How do I annotate the topology with private notes?	43
11.7	How do I handle API upgrades?	43
12	Module Index	45
12.1	Modules	45
13	Data Structure Index	47
13.1	Data Structures	47
14	Module Documentation	49
14.1	API version	49
14.1.1	Detailed Description	49
14.1.2	Macro Definition Documentation	49
14.1.2.1	HWLOC_API_VERSION	49
14.1.3	Function Documentation	49
14.1.3.1	hwloc_get_api_version	49
14.2	Topology context	50
14.2.1	Detailed Description	50
14.2.2	Typedef Documentation	50
14.2.2.1	hwloc_topology_t	50

14.3 Object sets (<code>hwloc_cpuset_t</code> and <code>hwloc_nodeset_t</code>)	51
14.3.1 Detailed Description	51
14.3.2 Typedef Documentation	51
14.3.2.1 <code>hwloc_const_cpuset_t</code>	51
14.3.2.2 <code>hwloc_const_nodeset_t</code>	51
14.3.2.3 <code>hwloc_cpuset_t</code>	51
14.3.2.4 <code>hwloc_nodeset_t</code>	51
14.4 Topology Object Types	52
14.4.1 Detailed Description	52
14.4.2 Typedef Documentation	52
14.4.2.1 <code>hwloc_obj_bridge_type_t</code>	52
14.4.2.2 <code>hwloc_obj_osdev_type_t</code>	52
14.4.3 Enumeration Type Documentation	52
14.4.3.1 <code>hwloc_compare_types_e</code>	52
14.4.3.2 <code>hwloc_obj_bridge_type_e</code>	53
14.4.3.3 <code>hwloc_obj_osdev_type_e</code>	53
14.4.3.4 <code>hwloc_obj_type_t</code>	53
14.4.4 Function Documentation	54
14.4.4.1 <code>hwloc_compare_types</code>	54
14.5 Topology Objects	55
14.5.1 Detailed Description	55
14.5.2 Typedef Documentation	55
14.5.2.1 <code>hwloc_obj_t</code>	55
14.6 Create and Destroy Topologies	56
14.6.1 Detailed Description	56
14.6.2 Function Documentation	56
14.6.2.1 <code>hwloc_topology_check</code>	56
14.6.2.2 <code>hwloc_topology_destroy</code>	56
14.6.2.3 <code>hwloc_topology_init</code>	56
14.6.2.4 <code>hwloc_topology_load</code>	57
14.7 Configure Topology Detection	58
14.7.1 Detailed Description	58
14.7.2 Enumeration Type Documentation	59
14.7.2.1 <code>hwloc_topology_flags_e</code>	59
14.7.3 Function Documentation	59
14.7.3.1 <code>hwloc_topology_get_support</code>	59
14.7.3.2 <code>hwloc_topology_ignore_all_keep_structure</code>	59

14.7.3.3	hwloc_topology_ignore_type	59
14.7.3.4	hwloc_topology_ignore_type_keep_structure	60
14.7.3.5	hwloc_topology_set_distance_matrix	60
14.7.3.6	hwloc_topology_set_flags	60
14.7.3.7	hwloc_topology_set_fsroot	60
14.7.3.8	hwloc_topology_set_pid	60
14.7.3.9	hwloc_topology_set_synthetic	61
14.7.3.10	hwloc_topology_set_xml	61
14.7.3.11	hwloc_topology_set_xmlbuffer	61
14.8	Tinker With Topologies	62
14.8.1	Detailed Description	62
14.8.2	Enumeration Type Documentation	62
14.8.2.1	hwloc_restrict_flags_e	62
14.8.3	Function Documentation	62
14.8.3.1	hwloc_free_xmlbuffer	62
14.8.3.2	hwloc_topology_export_xml	62
14.8.3.3	hwloc_topology_export_xmlbuffer	63
14.8.3.4	hwloc_topology_insert_misc_object_by_cpuset	63
14.8.3.5	hwloc_topology_insert_misc_object_by_parent	63
14.8.3.6	hwloc_topology_restrict	63
14.9	Get Some Topology Information	65
14.9.1	Detailed Description	65
14.9.2	Enumeration Type Documentation	65
14.9.2.1	hwloc_get_type_depth_e	65
14.9.3	Function Documentation	65
14.9.3.1	hwloc_get_depth_type	65
14.9.3.2	hwloc_get_nobjs_by_depth	66
14.9.3.3	hwloc_get_nobjs_by_type	66
14.9.3.4	hwloc_get_type_depth	66
14.9.3.5	hwloc_topology_get_depth	66
14.9.3.6	hwloc_topology_is_thissystem	66
14.10	Retrieve Objects	67
14.10.1	Detailed Description	67
14.10.2	Function Documentation	67
14.10.2.1	hwloc_get_obj_by_depth	67
14.10.2.2	hwloc_get_obj_by_type	67
14.11	Object/String Conversion	68

14.11.1 Detailed Description	68
14.11.2 Function Documentation	68
14.11.2.1 hwloc_obj_add_info	68
14.11.2.2 hwloc_obj_attr_sprintf	68
14.11.2.3 hwloc_obj_cpuset_sprintf	68
14.11.2.4 hwloc_obj_get_info_by_name	69
14.11.2.5 hwloc_obj_sprintf	69
14.11.2.6 hwloc_obj_type_of_string	69
14.11.2.7 hwloc_obj_type_sprintf	69
14.11.2.8 hwloc_obj_type_string	70
14.12 CPU binding	71
14.12.1 Detailed Description	71
14.12.2 Enumeration Type Documentation	72
14.12.2.1 hwloc_cpupbind_flags_t	72
14.12.3 Function Documentation	72
14.12.3.1 hwloc_get_cpupbind	72
14.12.3.2 hwloc_get_last_cpu_location	72
14.12.3.3 hwloc_get_proc_cpupbind	73
14.12.3.4 hwloc_get_proc_last_cpu_location	73
14.12.3.5 hwloc_get_thread_cpupbind	73
14.12.3.6 hwloc_set_cpupbind	73
14.12.3.7 hwloc_set_proc_cpupbind	73
14.12.3.8 hwloc_set_thread_cpupbind	74
14.13 Memory binding	75
14.13.1 Detailed Description	75
14.13.2 Enumeration Type Documentation	76
14.13.2.1 hwloc_membind_flags_t	76
14.13.2.2 hwloc_membind_policy_t	77
14.13.3 Function Documentation	77
14.13.3.1 hwloc_alloc	77
14.13.3.2 hwloc_alloc_membind	78
14.13.3.3 hwloc_alloc_membind_nodeset	78
14.13.3.4 hwloc_free	78
14.13.3.5 hwloc_get_area_membind	78
14.13.3.6 hwloc_get_area_membind_nodeset	79
14.13.3.7 hwloc_get_membind	79
14.13.3.8 hwloc_get_membind_nodeset	79

14.13.3.9	hwloc_get_proc_mbind	80
14.13.3.10	hwloc_get_proc_mbind_nodese	80
14.13.3.11	hwloc_set_area_mbind	81
14.13.3.12	hwloc_set_area_mbind_nodese	81
14.13.3.13	hwloc_set_mbind	81
14.13.3.14	hwloc_set_mbind_nodese	82
14.13.3.15	hwloc_set_proc_mbind	82
14.13.3.16	hwloc_set_proc_mbind_nodese	82
14.14	Object Type Helpers	83
14.14.1	Detailed Description	83
14.14.2	Function Documentation	83
14.14.2.1	hwloc_get_type_or_above_depth	83
14.14.2.2	hwloc_get_type_or_below_depth	83
14.15	Basic Traversal Helpers	84
14.15.1	Detailed Description	84
14.15.2	Function Documentation	84
14.15.2.1	hwloc_get_ancestor_obj_by_depth	84
14.15.2.2	hwloc_get_ancestor_obj_by_type	84
14.15.2.3	hwloc_get_common_ancestor_obj	84
14.15.2.4	hwloc_get_next_child	84
14.15.2.5	hwloc_get_next_obj_by_depth	85
14.15.2.6	hwloc_get_next_obj_by_type	85
14.15.2.7	hwloc_get_pu_obj_by_os_index	85
14.15.2.8	hwloc_get_root_obj	85
14.15.2.9	hwloc_obj_is_in_subtree	85
14.16	Finding Objects Inside a CPU set	86
14.16.1	Detailed Description	86
14.16.2	Function Documentation	86
14.16.2.1	hwloc_get_first_largest_obj_inside_cpuset	86
14.16.2.2	hwloc_get_largest_objs_inside_cpuset	86
14.16.2.3	hwloc_get_nbojs_inside_cpuset_by_depth	86
14.16.2.4	hwloc_get_nbojs_inside_cpuset_by_type	87
14.16.2.5	hwloc_get_next_obj_inside_cpuset_by_depth	87
14.16.2.6	hwloc_get_next_obj_inside_cpuset_by_type	87
14.16.2.7	hwloc_get_obj_inside_cpuset_by_depth	87
14.16.2.8	hwloc_get_obj_inside_cpuset_by_type	87
14.17	Finding a single Object covering at least CPU set	88

14.17.1 Detailed Description	88
14.17.2 Function Documentation	88
14.17.2.1 hwloc_get_child_covering_cpuset	88
14.17.2.2 hwloc_get_obj_covering_cpuset	88
14.18 Finding a set of similar Objects covering at least a CPU set	89
14.18.1 Detailed Description	89
14.18.2 Function Documentation	89
14.18.2.1 hwloc_get_next_obj_covering_cpuset_by_depth	89
14.18.2.2 hwloc_get_next_obj_covering_cpuset_by_type	89
14.19 Cache-specific Finding Helpers	90
14.19.1 Detailed Description	90
14.19.2 Function Documentation	90
14.19.2.1 hwloc_get_cache_covering_cpuset	90
14.19.2.2 hwloc_get_shared_cache_covering_obj	90
14.20 Advanced Traversal Helpers	91
14.20.1 Detailed Description	91
14.20.2 Function Documentation	91
14.20.2.1 hwloc_get_closest_objs	91
14.20.2.2 hwloc_get_obj_below_array_by_type	91
14.20.2.3 hwloc_get_obj_below_by_type	91
14.21 Binding Helpers	93
14.21.1 Detailed Description	93
14.21.2 Function Documentation	93
14.21.2.1 hwloc_alloc_membind_policy	93
14.21.2.2 hwloc_alloc_membind_policy_nodest	93
14.21.2.3 hwloc_distribute	93
14.21.2.4 hwloc_distributev	93
14.22 Cpuset Helpers	94
14.22.1 Detailed Description	94
14.22.2 Function Documentation	94
14.22.2.1 hwloc_topology_get_allowed_cpuset	94
14.22.2.2 hwloc_topology_get_complete_cpuset	94
14.22.2.3 hwloc_topology_get_online_cpuset	95
14.22.2.4 hwloc_topology_get_topology_cpuset	95
14.23 Nodest Helpers	96
14.23.1 Detailed Description	96
14.23.2 Function Documentation	96

14.23.2.1	hwloc_topology_get_allowed_nodest	96
14.23.2.2	hwloc_topology_get_complete_nodest	96
14.23.2.3	hwloc_topology_get_topology_nodest	97
14.24	Conversion between cpuset and nodest	98
14.24.1	Detailed Description	98
14.24.2	Function Documentation	98
14.24.2.1	hwloc_cpuset_from_nodest	98
14.24.2.2	hwloc_cpuset_from_nodest_strict	98
14.24.2.3	hwloc_cpuset_to_nodest	98
14.24.2.4	hwloc_cpuset_to_nodest_strict	99
14.25	Distances	100
14.25.1	Detailed Description	100
14.25.2	Function Documentation	100
14.25.2.1	hwloc_get_distance_matrix_covering_obj_by_depth	100
14.25.2.2	hwloc_get_latency	100
14.25.2.3	hwloc_get_whole_distance_matrix_by_depth	100
14.25.2.4	hwloc_get_whole_distance_matrix_by_type	101
14.26	Advanced I/O object traversal helpers	102
14.26.1	Detailed Description	102
14.26.2	Function Documentation	102
14.26.2.1	hwloc_bridge_covers_pcibus	102
14.26.2.2	hwloc_get_hostbridge_by_pcibus	102
14.26.2.3	hwloc_get_next_bridge	102
14.26.2.4	hwloc_get_next_osdev	102
14.26.2.5	hwloc_get_next_pcidev	103
14.26.2.6	hwloc_get_non_io_ancestor_obj	103
14.26.2.7	hwloc_get_pcidev_by_busid	103
14.26.2.8	hwloc_get_pcidev_by_busidstring	103
14.27	The bitmap API	104
14.27.1	Detailed Description	105
14.27.2	Macro Definition Documentation	105
14.27.2.1	hwloc_bitmap_foreach_begin	105
14.27.2.2	hwloc_bitmap_foreach_end	106
14.27.3	Typedef Documentation	106
14.27.3.1	hwloc_bitmap_t	106
14.27.3.2	hwloc_const_bitmap_t	106
14.27.4	Function Documentation	106

14.27.4.1	<code>hwloc_bitmap_allbut</code>	106
14.27.4.2	<code>hwloc_bitmap_alloc</code>	106
14.27.4.3	<code>hwloc_bitmap_alloc_full</code>	106
14.27.4.4	<code>hwloc_bitmap_and</code>	106
14.27.4.5	<code>hwloc_bitmap_andnot</code>	106
14.27.4.6	<code>hwloc_bitmap_asprintf</code>	107
14.27.4.7	<code>hwloc_bitmap_clr</code>	107
14.27.4.8	<code>hwloc_bitmap_clr_range</code>	107
14.27.4.9	<code>hwloc_bitmap_compare</code>	107
14.27.4.10	<code>hwloc_bitmap_compare_first</code>	107
14.27.4.11	<code>hwloc_bitmap_copy</code>	107
14.27.4.12	<code>hwloc_bitmap_dup</code>	107
14.27.4.13	<code>hwloc_bitmap_fill</code>	107
14.27.4.14	<code>hwloc_bitmap_first</code>	107
14.27.4.15	<code>hwloc_bitmap_free</code>	108
14.27.4.16	<code>hwloc_bitmap_from_ith_ulong</code>	108
14.27.4.17	<code>hwloc_bitmap_from_ulong</code>	108
14.27.4.18	<code>hwloc_bitmap_intersects</code>	108
14.27.4.19	<code>hwloc_bitmap_isequal</code>	108
14.27.4.20	<code>hwloc_bitmap_isfull</code>	108
14.27.4.21	<code>hwloc_bitmap_isincluded</code>	108
14.27.4.22	<code>hwloc_bitmap_isset</code>	108
14.27.4.23	<code>hwloc_bitmap_iszero</code>	108
14.27.4.24	<code>hwloc_bitmap_last</code>	108
14.27.4.25	<code>hwloc_bitmap_list_asprintf</code>	109
14.27.4.26	<code>hwloc_bitmap_list_snprintf</code>	109
14.27.4.27	<code>hwloc_bitmap_list_sscanf</code>	109
14.27.4.28	<code>hwloc_bitmap_next</code>	109
14.27.4.29	<code>hwloc_bitmap_not</code>	109
14.27.4.30	<code>hwloc_bitmap_only</code>	109
14.27.4.31	<code>hwloc_bitmap_or</code>	109
14.27.4.32	<code>hwloc_bitmap_set</code>	109
14.27.4.33	<code>hwloc_bitmap_set_ith_ulong</code>	110
14.27.4.34	<code>hwloc_bitmap_set_range</code>	110
14.27.4.35	<code>hwloc_bitmap_singlify</code>	110
14.27.4.36	<code>hwloc_bitmap_snprintf</code>	110
14.27.4.37	<code>hwloc_bitmap_sscanf</code>	110

14.27.4.38	hwloc_bitmap_taskset_asprintf	110
14.27.4.39	hwloc_bitmap_taskset_sprintf	110
14.27.4.40	hwloc_bitmap_taskset_sscanf	111
14.27.4.41	hwloc_bitmap_to_ith_ulong	111
14.27.4.42	hwloc_bitmap_to_ulong	111
14.27.4.43	hwloc_bitmap_weight	111
14.27.4.44	hwloc_bitmap_xor	111
14.27.4.45	hwloc_bitmap_zero	111
14.28	Helpers for manipulating glibc sched affinity	112
14.28.1	Detailed Description	112
14.28.2	Function Documentation	112
14.28.2.1	hwloc_cpuset_from_glibc_sched_affinity	112
14.28.2.2	hwloc_cpuset_to_glibc_sched_affinity	112
14.29	Linux-only helpers	113
14.29.1	Detailed Description	113
14.29.2	Function Documentation	113
14.29.2.1	hwloc_linux_get_tid_cpupbind	113
14.29.2.2	hwloc_linux_parse_cpumap_file	113
14.29.2.3	hwloc_linux_set_tid_cpupbind	113
14.30	Helpers for manipulating Linux libnuma unsigned long masks	114
14.30.1	Detailed Description	114
14.30.2	Function Documentation	114
14.30.2.1	hwloc_cpuset_from_linux_libnuma_ulong	114
14.30.2.2	hwloc_cpuset_to_linux_libnuma_ulong	114
14.30.2.3	hwloc_nodeuset_from_linux_libnuma_ulong	114
14.30.2.4	hwloc_nodeuset_to_linux_libnuma_ulong	115
14.31	Helpers for manipulating Linux libnuma bitmask	116
14.31.1	Detailed Description	116
14.31.2	Function Documentation	116
14.31.2.1	hwloc_cpuset_from_linux_libnuma_bitmask	116
14.31.2.2	hwloc_cpuset_to_linux_libnuma_bitmask	116
14.31.2.3	hwloc_nodeuset_from_linux_libnuma_bitmask	116
14.31.2.4	hwloc_nodeuset_to_linux_libnuma_bitmask	116
14.32	Helpers for manipulating Linux libnuma nodemask_t	118
14.32.1	Detailed Description	118
14.32.2	Function Documentation	118
14.32.2.1	hwloc_cpuset_from_linux_libnuma_nodemask	118

14.32.2.2 hwloc_cpuset_to_linux_libnuma_nodemask	118
14.32.2.3 hwloc_nodeset_from_linux_libnuma_nodemask	118
14.32.2.4 hwloc_nodeset_to_linux_libnuma_nodemask	118
14.33 CUDA Driver API Specific Functions	119
14.33.1 Detailed Description	119
14.33.2 Function Documentation	119
14.33.2.1 hwloc_cuda_get_device_cpuset	119
14.34 CUDA Runtime API Specific Functions	120
14.34.1 Detailed Description	120
14.34.2 Function Documentation	120
14.34.2.1 hwloc_cudart_get_device_cpuset	120
14.35 OpenFabrics-Specific Functions	121
14.35.1 Detailed Description	121
14.35.2 Function Documentation	121
14.35.2.1 hwloc_ibv_get_device_cpuset	121
14.36 Myrinet Express-Specific Functions	122
14.36.1 Detailed Description	122
14.36.2 Function Documentation	122
14.36.2.1 hwloc_mx_board_get_device_cpuset	122
14.36.2.2 hwloc_mx_endpoint_get_device_cpuset	122
15 Data Structure Documentation	123
15.1 hwloc_obj_attr_u::hwloc_bridge_attr_s Struct Reference	123
15.1.1 Detailed Description	123
15.1.2 Field Documentation	123
15.1.2.1 depth	123
15.1.2.2 domain	123
15.1.2.3 downstream	123
15.1.2.4 downstream_type	124
15.1.2.5 pci	124
15.1.2.6 pci	124
15.1.2.7 secondary_bus	124
15.1.2.8 subordinate_bus	124
15.1.2.9 upstream	124
15.1.2.10 upstream_type	124
15.2 hwloc_obj_attr_u::hwloc_cache_attr_s Struct Reference	124
15.2.1 Detailed Description	124

15.2.2	Field Documentation	124
15.2.2.1	associativity	124
15.2.2.2	depth	124
15.2.2.3	linesize	124
15.2.2.4	size	125
15.3	hwloc_distances_s Struct Reference	125
15.3.1	Detailed Description	125
15.3.2	Field Documentation	125
15.3.2.1	latency	125
15.3.2.2	latency_base	125
15.3.2.3	latency_max	125
15.3.2.4	nbobjs	126
15.3.2.5	relative_depth	126
15.4	hwloc_obj_attr_u::hwloc_group_attr_s Struct Reference	126
15.4.1	Detailed Description	126
15.4.2	Field Documentation	126
15.4.2.1	depth	126
15.5	hwloc_obj Struct Reference	126
15.5.1	Detailed Description	127
15.5.2	Field Documentation	127
15.5.2.1	allowed_cpuset	127
15.5.2.2	allowed_nodeset	128
15.5.2.3	arity	128
15.5.2.4	attr	128
15.5.2.5	children	128
15.5.2.6	complete_cpuset	128
15.5.2.7	complete_nodeset	128
15.5.2.8	cpuset	129
15.5.2.9	depth	129
15.5.2.10	distances	129
15.5.2.11	distances_count	129
15.5.2.12	first_child	129
15.5.2.13	infos	129
15.5.2.14	infos_count	129
15.5.2.15	last_child	129
15.5.2.16	logical_index	129
15.5.2.17	memory	129

15.5.2.18	name	130
15.5.2.19	next_cousin	130
15.5.2.20	next_sibling	130
15.5.2.21	nodeset	130
15.5.2.22	online_cpuset	130
15.5.2.23	os_index	130
15.5.2.24	os_level	130
15.5.2.25	parent	131
15.5.2.26	prev_cousin	131
15.5.2.27	prev_sibling	131
15.5.2.28	sibling_rank	131
15.5.2.29	type	131
15.5.2.30	userdata	131
15.6	hwloc_obj_attr_u Union Reference	131
15.6.1	Detailed Description	132
15.6.2	Field Documentation	132
15.6.2.1	bridge	132
15.6.2.2	cache	132
15.6.2.3	group	132
15.6.2.4	osdev	132
15.6.2.5	pcidev	132
15.7	hwloc_obj_info_s Struct Reference	132
15.7.1	Detailed Description	132
15.7.2	Field Documentation	132
15.7.2.1	name	132
15.7.2.2	value	133
15.8	hwloc_obj_memory_s::hwloc_obj_memory_page_type_s Struct Reference	133
15.8.1	Detailed Description	133
15.8.2	Field Documentation	133
15.8.2.1	count	133
15.8.2.2	size	133
15.9	hwloc_obj_memory_s Struct Reference	133
15.9.1	Detailed Description	134
15.9.2	Field Documentation	134
15.9.2.1	local_memory	134
15.9.2.2	page_types	134
15.9.2.3	page_types_len	134

15.9.2.4	total_memory	134
15.10	hwloc_obj_attr_u::hwloc_osdev_attr_s Struct Reference	134
15.10.1	Detailed Description	134
15.10.2	Field Documentation	135
15.10.2.1	type	135
15.11	hwloc_obj_attr_u::hwloc_pcidev_attr_s Struct Reference	135
15.11.1	Detailed Description	135
15.11.2	Field Documentation	135
15.11.2.1	bus	135
15.11.2.2	class_id	135
15.11.2.3	dev	135
15.11.2.4	device_id	135
15.11.2.5	domain	135
15.11.2.6	func	135
15.11.2.7	linkspeed	135
15.11.2.8	revision	135
15.11.2.9	subdevice_id	136
15.11.2.10	subvendor_id	136
15.11.2.11	vendor_id	136
15.12	hwloc_topology_cpupbind_support Struct Reference	136
15.12.1	Detailed Description	136
15.12.2	Field Documentation	136
15.12.2.1	get_proc_cpupbind	136
15.12.2.2	get_proc_last_cpu_location	136
15.12.2.3	get_thisproc_cpupbind	136
15.12.2.4	get_thisproc_last_cpu_location	137
15.12.2.5	get_thisthread_cpupbind	137
15.12.2.6	get_thisthread_last_cpu_location	137
15.12.2.7	get_thread_cpupbind	137
15.12.2.8	set_proc_cpupbind	137
15.12.2.9	set_thisproc_cpupbind	137
15.12.2.10	set_thisthread_cpupbind	137
15.12.2.11	set_thread_cpupbind	137
15.13	hwloc_topology_discovery_support Struct Reference	137
15.13.1	Detailed Description	138
15.13.2	Field Documentation	138
15.13.2.1	pu	138

15.14hwloc_topology_membind_support Struct Reference	138
15.14.1 Detailed Description	138
15.14.2 Field Documentation	138
15.14.2.1 alloc_membind	138
15.14.2.2 bind_membind	139
15.14.2.3 firsttouch_membind	139
15.14.2.4 get_area_membind	139
15.14.2.5 get_proc_membind	139
15.14.2.6 get_thisproc_membind	139
15.14.2.7 get_thisthread_membind	139
15.14.2.8 interleave_membind	139
15.14.2.9 migrate_membind	139
15.14.2.10nexttouch_membind	139
15.14.2.11replicate_membind	139
15.14.2.12set_area_membind	139
15.14.2.13set_proc_membind	140
15.14.2.14set_thisproc_membind	140
15.14.2.15set_thisthread_membind	140
15.15hwloc_topology_support Struct Reference	140
15.15.1 Detailed Description	140
15.15.2 Field Documentation	140
15.15.2.1 cpubind	140
15.15.2.2 discovery	140
15.15.2.3 membind	140

Chapter 1

Hardware Locality

Portable abstraction of hierarchical architectures for high-performance computing

1.1 Introduction

hwloc provides command line tools and a C API to obtain the hierarchical map of key computing elements, such as: NUMA memory nodes, shared caches, processor sockets, processor cores, processing units (logical processors or "threads") and even I/O devices. hwloc also gathers various attributes such as cache and memory information, and is portable across a variety of different operating systems and platforms.

hwloc primarily aims at helping high-performance computing (HPC) applications, but is also applicable to any project seeking to exploit code and/or data locality on modern computing platforms.

Note that the hwloc project represents the merger of the libtopology project from inria and the Portable Linux Processor Affinity (PLPA) sub-project from Open MPI. *Both of these prior projects are now deprecated.* The first hwloc release was essentially a "re-branding" of the libtopology code base, but with both a few genuinely new features and a few PLPA-like features added in. Prior releases of hwloc included documentation about switching from PLPA to hwloc; this documentation has been dropped on the assumption that everyone who was using PLPA has already switched to hwloc.

hwloc supports the following operating systems:

- Linux (including old kernels not having sysfs topology information, with knowledge of cpusets, offline CPUs, ScaleMP vSMP, and Kerrighed support)
- Solaris
- AIX
- Darwin / OS X
- FreeBSD and its variants, such as kFreeBSD/GNU
- OSF/1 (a.k.a., Tru64)
- HP-UX
- Microsoft Windows

Since it uses standard Operating System information, hwloc's support is mostly independent from the processor type (x86, powerpc, ...) and just relies on the Operating System support. The only exception to this is kFreeBSD, which does

not support topology information, and hwloc thus uses an x86-only CPUID-based backend (which could be used for other OSes too).

To check whether hwloc works on a particular machine, just try to build it and run `lstopo`. If some things do not look right (e.g. bogus or missing cache information), see [Questions and Bugs](#) below.

hwloc only reports the number of processors on unsupported operating systems; no topology information is available.

For development and debugging purposes, hwloc also offers the ability to work on "fake" topologies:

- Symmetrical tree of resources generated from a list of level arities
- Remote machine simulation through the gathering of Linux sysfs topology files

hwloc can display the topology in a human-readable format, either in graphical mode (X11), or by exporting in one of several different formats, including: plain text, PDF, PNG, and FIG (see [CLI Examples](#) below). Note that some of the export formats require additional support libraries.

hwloc offers a programming interface for manipulating topologies and objects. It also brings a powerful CPU bitmap API that is used to describe topology objects location on physical/logical processors. See the [Programming Interface](#) below. It may also be used to binding applications onto certain cores or memory nodes. Several utility programs are also provided to ease command-line manipulation of topology objects, binding of processes, and so on.

Perl bindings are available from Bernd Kallies [on CPAN](#):

Python bindings are available from Guy Streeeter:

- [Fedora RPM and tarball](#).
- [git tree \(html\)](#).

1.2 Installation

hwloc (<http://www.open-mpi.org/projects/hwloc/>) is available under the BSD license. It is hosted as a sub-project of the overall Open MPI project (<http://www.open-mpi.org/>). Note that hwloc does not require any functionality from Open MPI – it is a wholly separate (and much smaller!) project and code base. It just happens to be hosted as part of the overall Open MPI project.

Nightly development snapshots are available on the web site. Additionally, the code can be directly checked out of Subversion:

```
shell$ svn checkout http://svn.open-mpi.org/svn/hwloc/trunk hwloc-trunk
shell$ cd hwloc-trunk
shell$ ./autogen.sh
```

Note that GNU Autoconf ≥ 2.63 , Automake ≥ 1.10 and Libtool $\geq 2.2.6$ are required when building from a Subversion checkout.

Installation by itself is the fairly common GNU-based process:

```
shell$ ./configure --prefix=...
shell$ make
shell$ make install
```

The hwloc command-line tool "lstopo" produces human-readable topology maps, as mentioned above. It can also export maps to the "fig" file format. Support for PDF, Postscript, and PNG exporting is provided if the "Cairo" development package can be found when hwloc is configured and build.

The hwloc core may also benefit from the following development packages:

- libnuma for memory binding and migration support on Linux.
- libxml2 for full XML import/export support (otherwise, the internal minimalistic parser will only be able to import XML files that were exported by the same hwloc release). See [Importing and exporting topologies from/to XML files](#) for details.
- hwloc can use one of two different libraries for I/O device discovery:
 1. libpciaccess (BSD).
 2. libpci, from the pciutils package (GPL).

Note that because of the possibility of GPL taint (remember that hwloc is BSD-licensed), hwloc's `configure` script will prefer `libpciaccess` to the `pciutils` package. Indeed, if `libpciaccess` is not found, hwloc will not use `pciutils` unless it is specifically requested via the `-enable-libpci` flag is provided.

Also note that if you install supplemental libraries in non-standard locations, hwloc's `configure` script may not be able to find them without some help. You may need to specify additional `CPPFLAGS`, `LDFLAGS`, or `PKG_CONFIG_PATH` values on the `configure` command line.

For example, if `libpciaccess` was installed into `/opt/pciaccess`, hwloc's `configure` script may not find it by default. Try adding `PKG_CONFIG_PATH` to the `./configure` command line, like this:

```
./configure PKG_CONFIG_PATH=/opt/pciaccess/lib/pkgconfig ...
```

1.3 CLI Examples

On a 4-socket 2-core machine with hyperthreading, the `lstopo` tool may show the following graphical output:

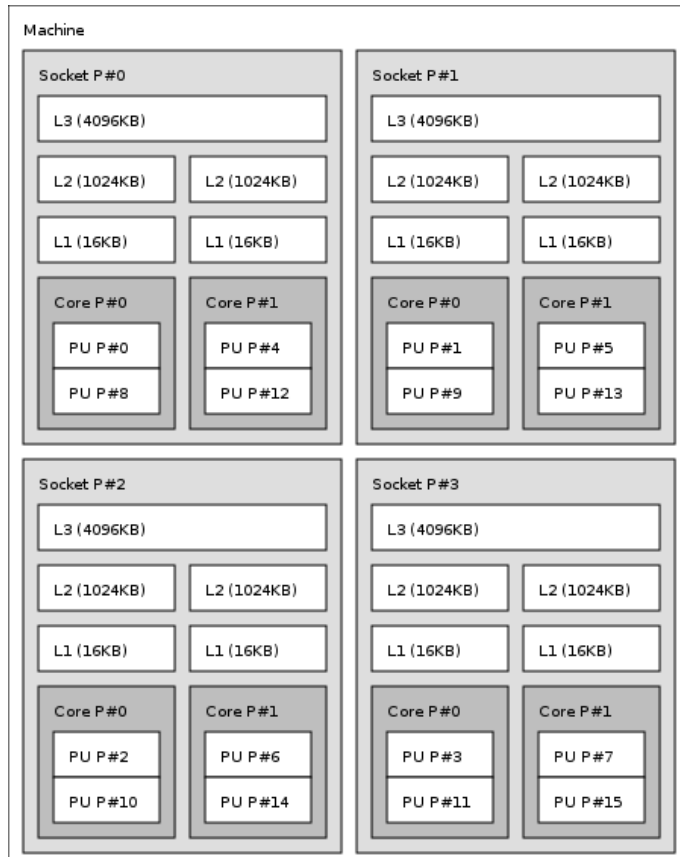

Here's the equivalent output in textual form:

```
Machine (16GB)
  Socket L#0 + L3 L#0 (4096KB)
    L2 L#0 (1024KB) + L1 L#0 (16KB) + Core L#0
      PU L#0 (P#0)
      PU L#1 (P#8)
    L2 L#1 (1024KB) + L1 L#1 (16KB) + Core L#1
      PU L#2 (P#4)
      PU L#3 (P#12)
  Socket L#1 + L3 L#1 (4096KB)
    L2 L#2 (1024KB) + L1 L#2 (16KB) + Core L#2
      PU L#4 (P#1)
      PU L#5 (P#9)
    L2 L#3 (1024KB) + L1 L#3 (16KB) + Core L#3
      PU L#6 (P#5)
      PU L#7 (P#13)
  Socket L#2 + L3 L#2 (4096KB)
    L2 L#4 (1024KB) + L1 L#4 (16KB) + Core L#4
      PU L#8 (P#2)
      PU L#9 (P#10)
    L2 L#5 (1024KB) + L1 L#5 (16KB) + Core L#5
      PU L#10 (P#6)
      PU L#11 (P#14)
  Socket L#3 + L3 L#3 (4096KB)
    L2 L#6 (1024KB) + L1 L#6 (16KB) + Core L#6
      PU L#12 (P#3)
      PU L#13 (P#11)
    L2 L#7 (1024KB) + L1 L#7 (16KB) + Core L#7
      PU L#14 (P#7)
      PU L#15 (P#15)
```

Finally, here's the equivalent output in XML. Long lines were artificially broken for document clarity (in the real output, each XML tag is on a single line), and only socket #0 is shown for brevity:

```
<?xml version="1.0" encoding="UTF-8"?>
<!DOCTYPE topology SYSTEM "hwloc.dtd">
<topology>
  <object type="Machine" os_level="-1" os_index="0" cpuset="0x0000ffff"
    complete_cpuset="0x0000ffff" online_cpuset="0x0000ffff"
    allowed_cpuset="0x0000ffff"
    dmi_board_vendor="Dell Computer Corporation" dmi_board_name="ORD318"
    local_memory="16648183808">
    <page_type size="4096" count="4064498"/>
    <page_type size="2097152" count="0"/>
    <object type="Socket" os_level="-1" os_index="0" cpuset="0x00001111"
      complete_cpuset="0x00001111" online_cpuset="0x00001111"
      allowed_cpuset="0x00001111">
      <object type="Cache" os_level="-1" cpuset="0x00001111"
        complete_cpuset="0x00001111" online_cpuset="0x00001111"
        allowed_cpuset="0x00001111" cache_size="4194304" depth="3"
        cache_linesize="64">
        <object type="Cache" os_level="-1" cpuset="0x00000101"
          complete_cpuset="0x00000101" online_cpuset="0x00000101"
          allowed_cpuset="0x00000101" cache_size="1048576" depth="2"
          cache_linesize="64">
          <object type="Cache" os_level="-1" cpuset="0x00000101"
            complete_cpuset="0x00000101" online_cpuset="0x00000101"
            allowed_cpuset="0x00000101" cache_size="16384" depth="1"
            cache_linesize="64">
            <object type="Core" os_level="-1" os_index="0" cpuset="0x00000101"
              complete_cpuset="0x00000101" online_cpuset="0x00000101"
              allowed_cpuset="0x00000101">
              <object type="PU" os_level="-1" os_index="0" cpuset="0x00000001"
                complete_cpuset="0x00000001" online_cpuset="0x00000001"
                allowed_cpuset="0x00000001"/>
            </object>
          </object>
        </object>
      </object>
    </object>
```

```

    <object type="PU" os_level="-1" os_index="8" cpuset="0x00000100"
      complete_cpuset="0x00000100" online_cpuset="0x00000100"
      allowed_cpuset="0x00000100"/>
  </object>
</object>
</object>
<object type="Cache" os_level="-1" cpuset="0x00001010"
  complete_cpuset="0x00001010" online_cpuset="0x00001010"
  allowed_cpuset="0x00001010" cache_size="1048576" depth="2"
  cache_linesize="64">
  <object type="Cache" os_level="-1" cpuset="0x00001010"
    complete_cpuset="0x00001010" online_cpuset="0x00001010"
    allowed_cpuset="0x00001010" cache_size="16384" depth="1"
    cache_linesize="64">
    <object type="Core" os_level="-1" os_index="1" cpuset="0x00001010"
      complete_cpuset="0x00001010" online_cpuset="0x00001010"
      allowed_cpuset="0x00001010">
      <object type="PU" os_level="-1" os_index="4" cpuset="0x00000010"
        complete_cpuset="0x00000010" online_cpuset="0x00000010"
        allowed_cpuset="0x00000010"/>
      <object type="PU" os_level="-1" os_index="12" cpuset="0x00001000"
        complete_cpuset="0x00001000" online_cpuset="0x00001000"
        allowed_cpuset="0x00001000"/>
    </object>
  </object>
</object>
</object>
</object>
<!-- ...other sockets listed here ... -->
</object>
</topology>

```

On a 4-socket 2-core Opteron NUMA machine, the `lstopo` tool may show the following graphical output:

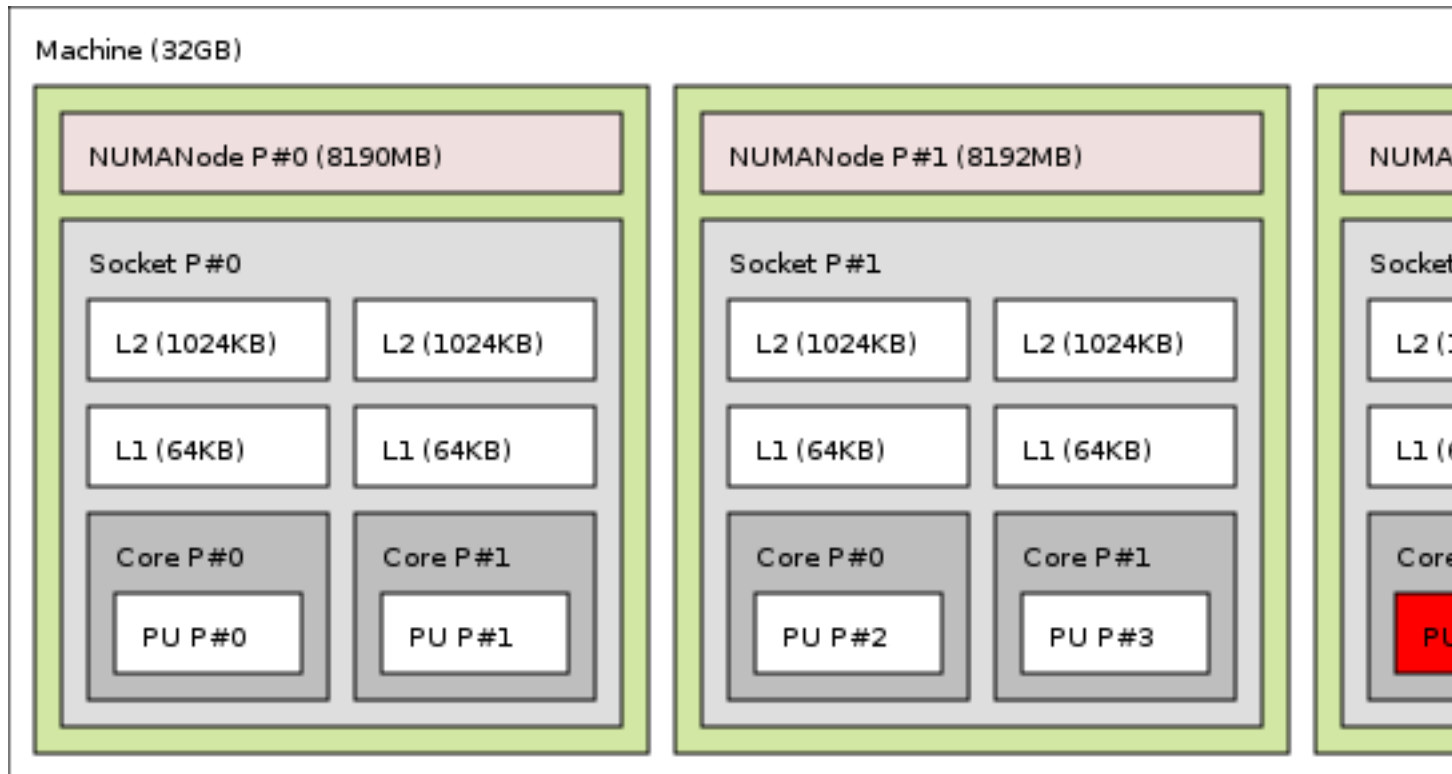

Figure 1.1: width=

Here's the equivalent output in textual form:

```
Machine (32GB)
  NUMANode L#0 (P#0 8190MB) + Socket L#0
    L2 L#0 (1024KB) + L1 L#0 (64KB) + Core L#0 + PU L#0 (P#0)
    L2 L#1 (1024KB) + L1 L#1 (64KB) + Core L#1 + PU L#1 (P#1)
  NUMANode L#1 (P#1 8192MB) + Socket L#1
    L2 L#2 (1024KB) + L1 L#2 (64KB) + Core L#2 + PU L#2 (P#2)
    L2 L#3 (1024KB) + L1 L#3 (64KB) + Core L#3 + PU L#3 (P#3)
  NUMANode L#2 (P#2 8192MB) + Socket L#2
    L2 L#4 (1024KB) + L1 L#4 (64KB) + Core L#4 + PU L#4 (P#4)
    L2 L#5 (1024KB) + L1 L#5 (64KB) + Core L#5 + PU L#5 (P#5)
  NUMANode L#3 (P#3 8192MB) + Socket L#3
    L2 L#6 (1024KB) + L1 L#6 (64KB) + Core L#6 + PU L#6 (P#6)
    L2 L#7 (1024KB) + L1 L#7 (64KB) + Core L#7 + PU L#7 (P#7)
```

And here's the equivalent output in XML. Similar to above, line breaks were added and only PU #0 is shown for brevity:

```
<?xml version="1.0" encoding="UTF-8"?>
<!DOCTYPE topology SYSTEM "hwloc.dtd">
<topology>
  <object type="Machine" os_level="-1" os_index="0" cpuset="0x000000ff"
    complete_cpuset="0x000000ff" online_cpuset="0x000000ff"
    allowed_cpuset="0x000000ff" nodeset="0x000000ff"
    complete_nodeset="0x000000ff" allowed_nodeset="0x000000ff"
    dmi_board_vendor="TYAN Computer Corp" dmi_board_name="S4881" >
    <page_type size="4096" count="0"/>
    <page_type size="2097152" count="0"/>
    <object type="NUMANode" os_level="-1" os_index="0" cpuset="0x00000003"
      complete_cpuset="0x00000003" online_cpuset="0x00000003"
```



```

    allowed_cpuset="0x00000003" nodeset="0x00000001"
    complete_nodeset="0x00000001" allowed_nodeset="0x00000001"
    local_memory="7514177536">
<page_type size="4096" count="1834516"/>
<page_type size="2097152" count="0"/>
<object type="Socket" os_level="-1" os_index="0" cpuset="0x00000003"
  complete_cpuset="0x00000003" online_cpuset="0x00000003"
  allowed_cpuset="0x00000003" nodeset="0x00000001"
  complete_nodeset="0x00000001" allowed_nodeset="0x00000001">
  <object type="Cache" os_level="-1" cpuset="0x00000001"
    complete_cpuset="0x00000001" online_cpuset="0x00000001"
    allowed_cpuset="0x00000001" nodeset="0x00000001"
    complete_nodeset="0x00000001" allowed_nodeset="0x00000001"
    cache_size="1048576" depth="2" cache_linesize="64">
    <object type="Cache" os_level="-1" cpuset="0x00000001"
      complete_cpuset="0x00000001" online_cpuset="0x00000001"
      allowed_cpuset="0x00000001" nodeset="0x00000001"
      complete_nodeset="0x00000001" allowed_nodeset="0x00000001"
      cache_size="65536" depth="1" cache_linesize="64">
      <object type="Core" os_level="-1" os_index="0"
        cpuset="0x00000001" complete_cpuset="0x00000001"
        online_cpuset="0x00000001" allowed_cpuset="0x00000001"
        nodeset="0x00000001" complete_nodeset="0x00000001"
        allowed_nodeset="0x00000001">
        <object type="PU" os_level="-1" os_index="0" cpuset="0x00000001"
          complete_cpuset="0x00000001" online_cpuset="0x00000001"
          allowed_cpuset="0x00000001" nodeset="0x00000001"
          complete_nodeset="0x00000001" allowed_nodeset="0x00000001"/>
        </object>
      </object>
    </object>
  </object>
</object>
<!-- ...more objects listed here ... -->
</topology>

```

On a 2-socket quad-core Xeon (pre-Nehalem, with 2 dual-core dies into each socket):

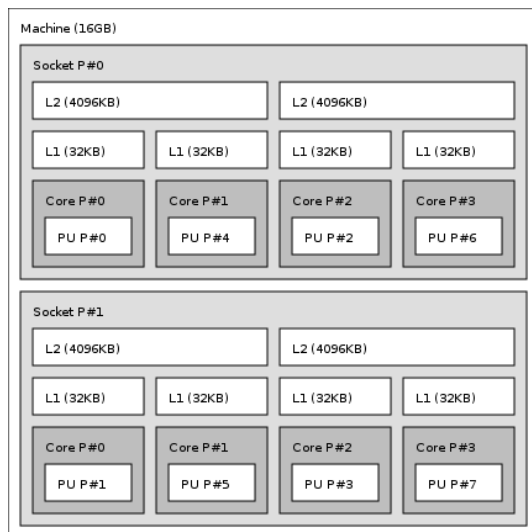

Here's the same output in textual form:

```

Machine (16GB)
Socket L#0
  L2 L#0 (4096KB)
    L1 L#0 (32KB) + Core L#0 + PU L#0 (P#0)
    L1 L#1 (32KB) + Core L#1 + PU L#1 (P#4)
  L2 L#1 (4096KB)
    L1 L#2 (32KB) + Core L#2 + PU L#2 (P#2)

```

```

    L1 L#3 (32KB) + Core L#3 + PU L#3 (P#6)
Socket L#1
  L2 L#2 (4096KB)
    L1 L#4 (32KB) + Core L#4 + PU L#4 (P#1)
    L1 L#5 (32KB) + Core L#5 + PU L#5 (P#5)
  L2 L#3 (4096KB)
    L1 L#6 (32KB) + Core L#6 + PU L#6 (P#3)
    L1 L#7 (32KB) + Core L#7 + PU L#7 (P#7)

```

And the same output in XML (line breaks added, only PU #0 shown):

```

<?xml version="1.0" encoding="UTF-8"?>
<!DOCTYPE topology SYSTEM "hwloc.dtd">
<topology>
  <object type="Machine" os_level="-1" os_index="0" cpuset="0x000000ff"
    complete_cpuset="0x000000ff" online_cpuset="0x000000ff"
    allowed_cpuset="0x000000ff" dmi_board_vendor="Dell Inc."
    dmi_board_name="0NR282" local_memory="16865292288">
    <page_type size="4096" count="4117503"/>
    <page_type size="2097152" count="0"/>
    <object type="Socket" os_level="-1" os_index="0" cpuset="0x00000055"
      complete_cpuset="0x00000055" online_cpuset="0x00000055"
      allowed_cpuset="0x00000055">
      <object type="Cache" os_level="-1" cpuset="0x00000011"
        complete_cpuset="0x00000011" online_cpuset="0x00000011"
        allowed_cpuset="0x00000011" cache_size="4194304" depth="2"
        cache_linesize="64">
        <object type="Cache" os_level="-1" cpuset="0x00000001"
          complete_cpuset="0x00000001" online_cpuset="0x00000001"
          allowed_cpuset="0x00000001" cache_size="32768" depth="1"
          cache_linesize="64">
          <object type="Core" os_level="-1" os_index="0" cpuset="0x00000001"
            complete_cpuset="0x00000001" online_cpuset="0x00000001"
            allowed_cpuset="0x00000001">
            <object type="PU" os_level="-1" os_index="0" cpuset="0x00000001"
              complete_cpuset="0x00000001" online_cpuset="0x00000001"
              allowed_cpuset="0x00000001"/>
            </object>
          </object>
        </object>
      <object type="Cache" os_level="-1" cpuset="0x00000010"
        complete_cpuset="0x00000010" online_cpuset="0x00000010"
        allowed_cpuset="0x00000010" cache_size="32768" depth="1"
        cache_linesize="64">
        <object type="Core" os_level="-1" os_index="1" cpuset="0x00000010"
          complete_cpuset="0x00000010" online_cpuset="0x00000010"
          allowed_cpuset="0x00000010">
          <object type="PU" os_level="-1" os_index="4" cpuset="0x00000010"
            complete_cpuset="0x00000010" online_cpuset="0x00000010"
            allowed_cpuset="0x00000010"/>
          </object>
        </object>
      </object>
    </object>
    <!-- ...more objects listed here ... -->
  </topology>

```

1.4 Programming Interface

The basic interface is available in [hwloc.h](#). It essentially offers low-level routines for advanced programmers that want to manually manipulate objects and follow links between them. Documentation for everything in [hwloc.h](#) are provided later in this document. Developers should also look at [hwloc/helper.h](#) (and also in this document, which provides good higher-level topology traversal examples).

To precisely define the vocabulary used by hwloc, a [Terms and Definitions](#) section is available and should probably be read first.

Each hwloc object contains a cpuset describing the list of processing units that it contains. These bitmaps may be used for [CPU binding](#) and [Memory binding](#). hwloc offers an extensive bitmap manipulation interface in [hwloc/bitmap.h](#).

Moreover, hwloc also comes with additional helpers for interoperability with several commonly used environments. See the [Interoperability With Other Software](#) section for details.

The complete API documentation is available in a full set of HTML pages, man pages, and self-contained PDF files (formatted for both both US letter and A4 formats) in the source tarball in `doc/doxygen-doc/`.

NOTE: If you are building the documentation from a Subversion checkout, you will need to have Doxygen and pdflatex installed – the documentation will be built during the normal "make" process. The documentation is installed during "make install" to `$prefix/share/doc/hwloc/` and your systems default man page tree (under `$prefix`, of course).

1.4.1 Portability

As shown in [CLI Examples](#), hwloc can obtain information on a wide variety of hardware topologies. However, some platforms and/or operating system versions will only report a subset of this information. For example, on an PPC64-based system with 32 cores (each with 2 hardware threads) running a default 2.6.18-based kernel from RHEL 5.4, hwloc is only able to glean information about NUMA nodes and processor units (PUs). No information about caches, sockets, or cores is available.

Similarly, Operating System have varying support for CPU and memory binding, e.g. while some Operating Systems provide interfaces for all kinds of CPU and memory bindings, some others provide only interfaces for a limited number of kinds of CPU and memory binding, and some do not provide any binding interface at all. Hwloc's binding functions would then simply return the ENOSYS error (Function not implemented), meaning that the underlying Operating System does not provide any interface for them. [CPU binding](#) and [Memory binding](#) provide more information on which hwloc binding functions should be preferred because interfaces for them are usually available on the supported Operating Systems.

Here's the graphical output from `lstopo` on this platform when Simultaneous Multi-Threading (SMT) is enabled:

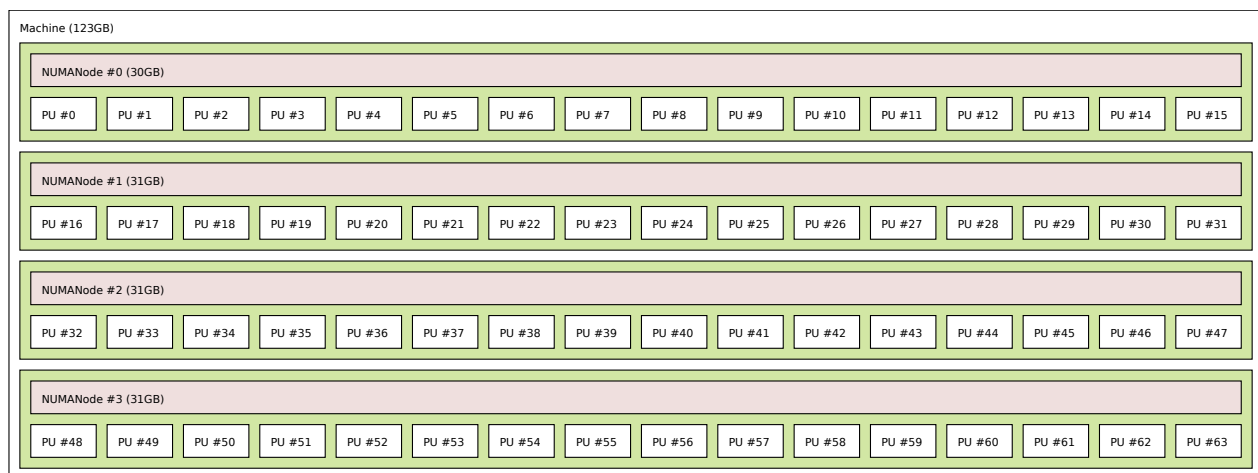

And here's the graphical output from `lstopo` on this platform when SMT is disabled:

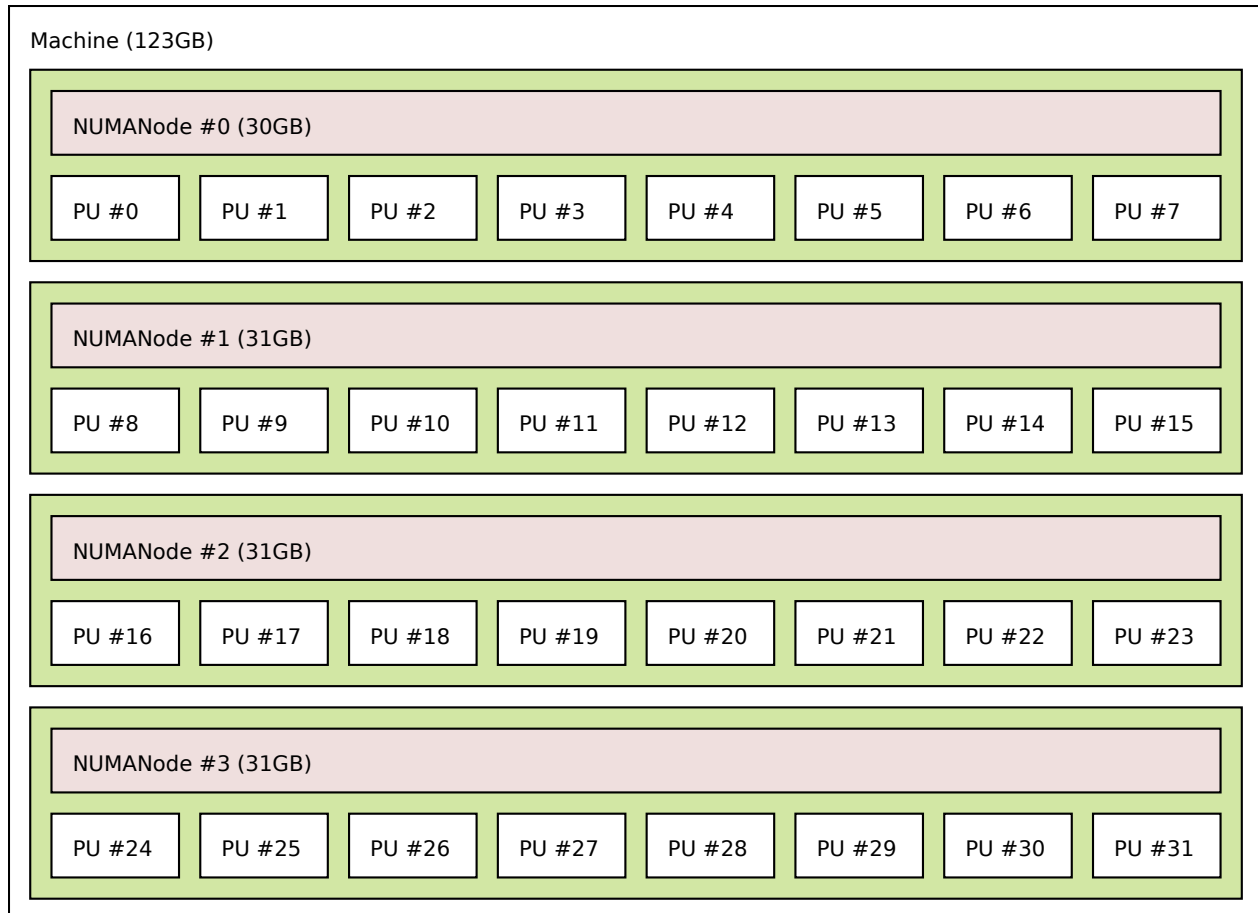

Notice that hwloc only sees half the PUs when SMT is disabled. PU #15, for example, seems to change location from NUMA node #0 to #1. In reality, no PUs "moved" – they were simply re-numbered when hwloc only saw half as many. Hence, PU #15 in the SMT-disabled picture probably corresponds to PU #30 in the SMT-enabled picture.

This same "PUs have disappeared" effect can be seen on other platforms – even platforms / OSs that provide much more information than the above PPC64 system. This is an unfortunate side-effect of how operating systems report information to hwloc.

Note that upgrading the Linux kernel on the same PPC64 system mentioned above to 2.6.34, hwloc is able to discover all the topology information. The following picture shows the entire topology layout when SMT is enabled:

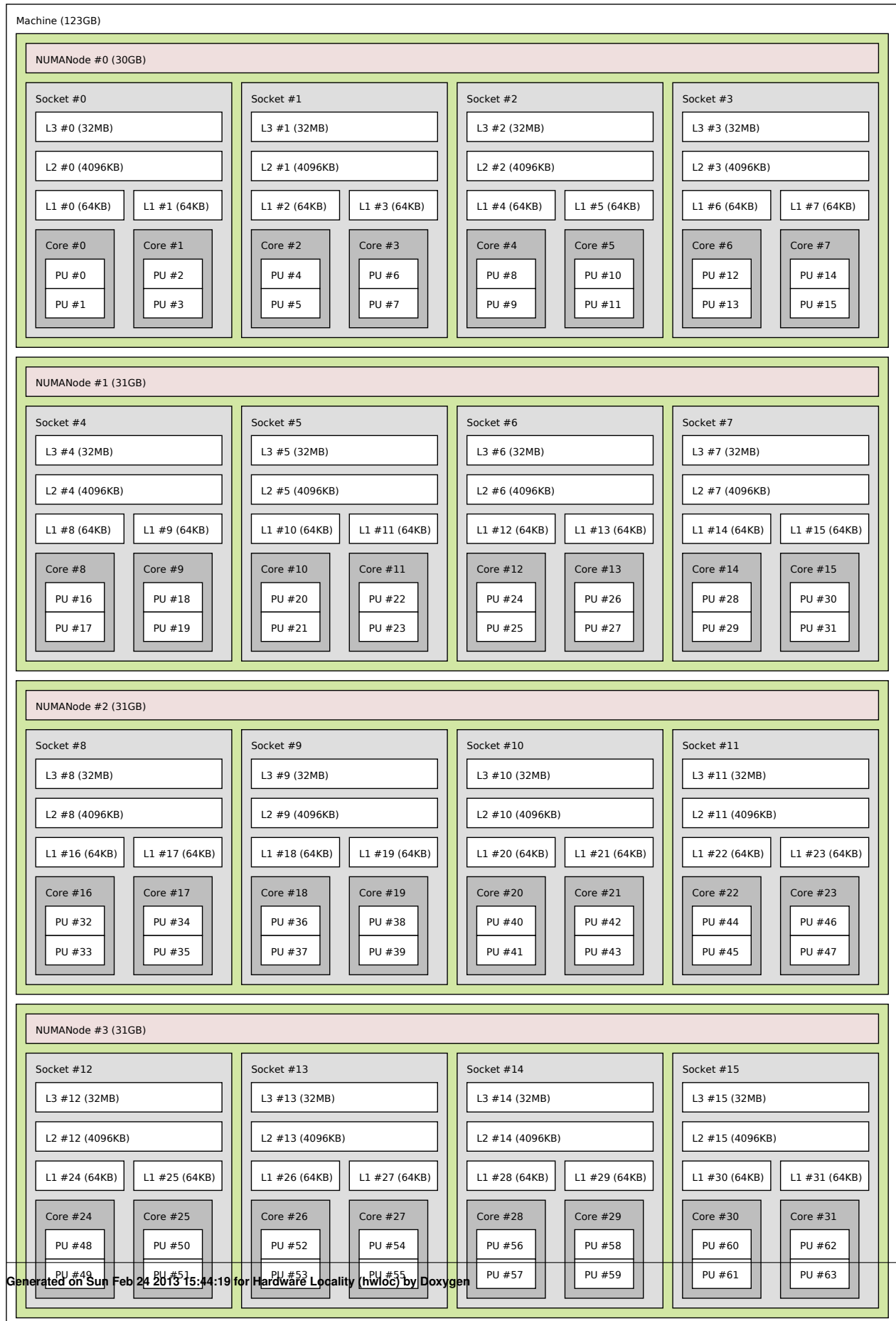

Developers using the hwloc API or XML output for portable applications should therefore be extremely careful to not make any assumptions about the structure of data that is returned. For example, per the above reported PPC topology, it is not safe to assume that PUs will always be descendants of cores.

Additionally, future hardware may insert new topology elements that are not available in this version of hwloc. Long-lived applications that are meant to span multiple different hardware platforms should also be careful about making structure assumptions. For example, there may someday be an element "lower" than a PU, or perhaps a new element may exist between a core and a PU.

1.4.2 API Example

The following small C example (named "hwloc-hello.c") prints the topology of the machine and bring the process to the first logical processor of the second core of the machine.

```

/* Example hwloc API program.
 *
 * Copyright © 2009-2010 inria. All rights reserved.
 * Copyright © 2009-2011 Université Bordeaux 1
 * Copyright © 2009-2010 Cisco Systems, Inc. All rights reserved.
 * See COPYING in top-level directory.
 *
 * hwloc-hello.c
 */

#include <hwloc.h>
#include <errno.h>
#include <stdio.h>
#include <string.h>

static void print_children(hwloc_topology_t topology,
                          hwloc_obj_t obj,
                          int depth)
{
    char string[128];
    unsigned i;

    hwloc_obj_snprintf(string, sizeof(string), topology, obj, "#", 0);
    printf("%s%s\n", 2*depth, string);
    for (i = 0; i < obj->arity; i++) {
        print_children(topology, obj->children[i], depth + 1);
    }
}

int main(void)
{
    int depth;
    unsigned i, n;
    unsigned long size;
    int levels;
    char string[128];
    int topodepth;
    hwloc_topology_t topology;
    hwloc_cpuset_t cpuset;
    hwloc_obj_t obj;

    /* Allocate and initialize topology object. */
    hwloc_topology_init(&topology);

    /* ... Optionally, put detection configuration here to ignore
     * some objects types, define a synthetic topology, etc...
     *
     * The default is to detect all the objects of the machine that
     * the caller is allowed to access. See Configure Topology
     * Detection. */

    /* Perform the topology detection. */
    hwloc_topology_load(topology);

    /* Optionally, get some additional topology information
     * in case we need the topology depth later. */
    topodepth = hwloc_topology_get_depth(topology);

```

```

/*****
 * First example:
 * Walk the topology with an array style, from level 0 (always
 * the system level) to the lowest level (always the proc level).
 *****/
for (depth = 0; depth < topodepth; depth++) {
    printf("*** Objects at level %d\n", depth);
    for (i = 0; i < hwloc_get_nbobjs_by_depth(topology, depth);
         i++) {
        hwloc_obj_snprintf(string, sizeof(string), topology,
                           hwloc_get_obj_by_depth(topology, depth, i),
                           "#", 0);
        printf("Index %u: %s\n", i, string);
    }
}

/*****
 * Second example:
 * Walk the topology with a tree style.
 *****/
printf("*** Printing overall tree\n");
print_children(topology, hwloc_get_root_obj(topology), 0);

/*****
 * Third example:
 * Print the number of sockets.
 *****/
depth = hwloc_get_type_depth(topology, HWLOC_OBJ_SOCKET);
if (depth == HWLOC_TYPE_DEPTH_UNKNOWN) {
    printf("*** The number of sockets is unknown\n");
} else {
    printf("*** %u socket(s)\n",
           hwloc_get_nbobjs_by_depth(topology, depth));
}

/*****
 * Fourth example:
 * Compute the amount of cache that the first logical processor
 * has above it.
 *****/
levels = 0;
size = 0;
for (obj = hwloc_get_obj_by_type(topology, HWLOC_OBJ_PU, 0);
     obj;
     obj = obj->parent)
    if (obj->type == HWLOC_OBJ_CACHE) {
        levels++;
        size += obj->attr->cache.size;
    }
printf("*** Logical processor 0 has %d caches totaling %luKB\n",
       levels, size / 1024);

/*****
 * Fifth example:
 * Bind to only one thread of the last core of the machine.
 *
 * First find out where cores are, or else smaller sets of CPUs if
 * the OS doesn't have the notion of a "core".
 *****/
depth = hwloc_get_type_or_below_depth(topology,
                                       HWLOC_OBJ_CORE);

/* Get last core. */
obj = hwloc_get_obj_by_depth(topology, depth,
                             hwloc_get_nbobjs_by_depth(topology, depth) - 1);
if (obj) {
    /* Get a copy of its cpuset that we may modify. */
    cpuset = hwloc_bitmap_dup(obj->cpuset);

    /* Get only one logical processor (in case the core is
       SMT/hyperthreaded). */
    hwloc_bitmap_singlify(cpuset);

    /* And try to bind ourself there. */
    if (hwloc_set_cpupbind(topology, cpuset, 0)) {
        char *str;
        int error = errno;
        hwloc_bitmap_asprintf(&str, obj->cpuset);
        printf("Couldn't bind to cpuset %s: %s\n", str, strerror(error));
        free(str);
    }
}

```

```

    }

    /* Free our cpuset copy */
    hwloc_bitmap_free(cpuset);
}

/*****
 * Sixth example:
 * Allocate some memory on the last NUMA node, bind some existing
 * memory to the last NUMA node.
 *****/
/* Get last node. */
n = hwloc_get_nbobjs_by_type(topology,
    HWLOC_OBJ_NODE);
if (n) {
    void *m;
    size = 1024*1024;

    obj = hwloc_get_obj_by_type(topology,
    HWLOC_OBJ_NODE, n - 1);
    m = hwloc_alloc_membind_nodeset(topology, size, obj->
    nodeset,
        HWLOC_MEMBIND_DEFAULT, 0);
    hwloc_free(topology, m, size);

    m = malloc(size);
    hwloc_set_area_membind_nodeset(topology, m, size, obj->
    nodeset,
        HWLOC_MEMBIND_DEFAULT, 0);
    free(m);
}

/* Destroy topology object. */
hwloc_topology_destroy(topology);

return 0;
}

```

hwloc provides a `pkg-config` executable to obtain relevant compiler and linker flags. For example, it can be used thusly to compile applications that utilize the hwloc library (assuming GNU Make):

```

CFLAGS += $(pkg-config --cflags hwloc)
LDLIBS += $(pkg-config --libs hwloc)
cc hwloc-hello.c $(CFLAGS) -o hwloc-hello $(LDLIBS)

```

On a machine with 4GB of RAM and 2 processor sockets – each socket of which has two processing cores – the output from running `hwloc-hello` could be something like the following:

```

shell$ ./hwloc-hello
*** Objects at level 0
Index 0: Machine(3938MB)
*** Objects at level 1
Index 0: Socket#0
Index 1: Socket#1
*** Objects at level 2
Index 0: Core#0
Index 1: Core#1
Index 2: Core#3
Index 3: Core#2
*** Objects at level 3
Index 0: PU#0
Index 1: PU#1
Index 2: PU#2
Index 3: PU#3
*** Printing overall tree
Machine(3938MB)
  Socket#0
    Core#0
      PU#0
    Core#1
      PU#1

```



```
Socket#1
  Core#3
    PU#2
  Core#2
    PU#3
*** 2 socket (s)
shell$
```

1.5 Questions and Bugs

Questions should be sent to the devel mailing list (<http://www.open-mpi.org/community/lists/hwloc.-php>). Bug reports should be reported in the tracker (<https://svn.open-mpi.org/trac/hwloc/>).

If hwloc discovers an incorrect topology for your machine, the very first thing you should check is to ensure that you have the most recent updates installed for your operating system. Indeed, most of hwloc topology discovery relies on hardware information retrieved through the operation system (e.g., via the /sys virtual filesystem of the Linux kernel). If upgrading your OS or Linux kernel does not solve your problem, you may also want to ensure that you are running the most recent version of the BIOS for your machine.

If those things fail, contact us on the mailing list for additional help. Please attach the output of `lstopo` after having given the `--enable-debug` option to `./configure` and rebuilt completely, to get debugging output. Also attach the `/proc + /sys` tarball generated by the installed script `hwloc-gather-topology.sh` when submitting problems about Linux, or send the output of `kstat cpu_info` in the Solaris case, or the output of `sysctl hw` in the Darwin or BSD cases.

1.6 History / Credits

hwloc is the evolution and merger of the libtopology (<http://runtime.bordeaux.inria.fr/libtopology/>) project and the Portable Linux Processor Affinity (PLPA) (<http://www.open-mpi.org/projects/plpa/>) project. Because of functional and ideological overlap, these two code bases and ideas were merged and released under the name "hwloc" as an Open MPI sub-project.

libtopology was initially developed by the inria Runtime Team-Project (<http://runtime.bordeaux.inria.-fr/>) (headed by Raymond Namyst (<http://dept-info.labri.fr/~namyst/>)). PLPA was initially developed by the Open MPI development team as a sub-project. Both are now deprecated in favor of hwloc, which is distributed as an Open MPI sub-project.

1.7 Further Reading

The documentation chapters include

- [Terms and Definitions](#)
- [Command-Line Tools](#)
- [Environment Variables](#)
- [CPU and Memory Binding Overview](#)
- [I/O Devices](#)
- [Importing and exporting topologies from/to XML files](#)
- [Interoperability With Other Software](#)

- [Thread Safety](#)
- [Embedding hwloc in Other Software](#)
- [Frequently Asked Questions](#)

Make sure to have had a look at those too!

Chapter 2

Terms and Definitions

Object Interesting kind of part of the system, such as a Core, a Cache, a Memory node, etc. The different types detected by hwloc are detailed in the [hwloc_obj_type_t](#) enumeration.

They are topologically sorted by CPU set into a tree.

CPU set The set of logical processors (or processing units) logically included in an object (if it makes sense). They are always expressed using physical logical processor numbers (as announced by the OS). They are implemented as the [hwloc_bitmap_t](#) opaque structure. hwloc CPU sets are just masks, they do *not* have any relation with an operating system actual binding notion like Linux' cpusets.

Node set The set of NUMA memory nodes logically included in an object (if it makes sense). They are always expressed using physical node numbers (as announced by the OS). They are implemented with the [hwloc_bitmap_t](#) opaque structure. as bitmaps.

Bitmap A possibly-infinite set of bits used for describing sets of objects such as CPUs (CPU sets) or memory nodes (Node sets). They are implemented with the [hwloc_bitmap_t](#) opaque structure.

Parent object The object logically containing the current object, for example because its CPU set includes the CPU set of the current object.

Ancestor object The parent object, or its own parent object, and so on.

Children object(s) The object (or objects) contained in the current object because their CPU set is included in the CPU set of the current object.

Arity The number of children of an object.

Sibling objects Objects which have the same parent. They usually have the same type (and hence are cousins, as well), but they may not if the topology is asymmetric.

Sibling rank Index to uniquely identify objects which have the same parent, and is always in the range [0, parent_arity).

Cousin objects Objects of the same type (and depth) as the current object, even if they do not have the same parent.

Level Set of objects of the same type and depth. All these objects are cousins.

Depth Nesting level in the object tree, starting from the 0th object.

OS or physical index The index that the operating system (OS) uses to identify the object. This may be completely arbitrary, non-unique, non-contiguous, not representative of logical proximity, and may depend on the BIOS configuration. That is why hwloc almost never uses them, only in the default lstopo output ($P : : x$) and cpuset masks.

Logical index Index to uniquely identify objects of the same type and depth, automatically computed by hwloc according to the topology. It expresses logical proximity in a generic way, i.e. objects which have adjacent logical indexes are adjacent in the topology. That is why hwloc almost always uses it in its API, since it expresses logical proximity. They can be shown (as `L: : x`) by `lstopo` thanks to the `-l` option. This index is always linear and in the range `[0, num_objs_same_type_same_level-1]`. Think of it as "cousin rank." The ordering is based on topology first, and then on OS CPU numbers, so it is stable across everything except firmware CPU renumbering. "Logical index" should not be confused with "Logical processor". A "Logical processor" (which in hwloc we rather call "processing unit" to avoid the confusion) has both a physical index (as chosen arbitrarily by BIOS/OS) and a logical index (as computed according to logical proximity by hwloc).

Logical processor

Processing unit The smallest processing element that can be represented by a hwloc object. It may be a single-core processor, a core of a multicore processor, or a single thread in SMT processor. "Logical processor" should not be confused with "Logical index of a processor". "Logical processor" is only one of the names which can be found in various documentations to designate a processing unit.

The following diagram can help to understand the vocabulary of the relationships by showing the example of a machine with two dual core sockets (with no hardware threads); thus, a topology with 4 levels. Each box with rounded corner corresponds to one `hwloc_obj_t`, containing the values of the different integer fields (depth, logical_index, etc.), and arrows show to which other `hwloc_obj_t` pointers point to (first_child, parent, etc.). The L2 cache of the last core is intentionally missing to show how asymmetric topologies are handled.

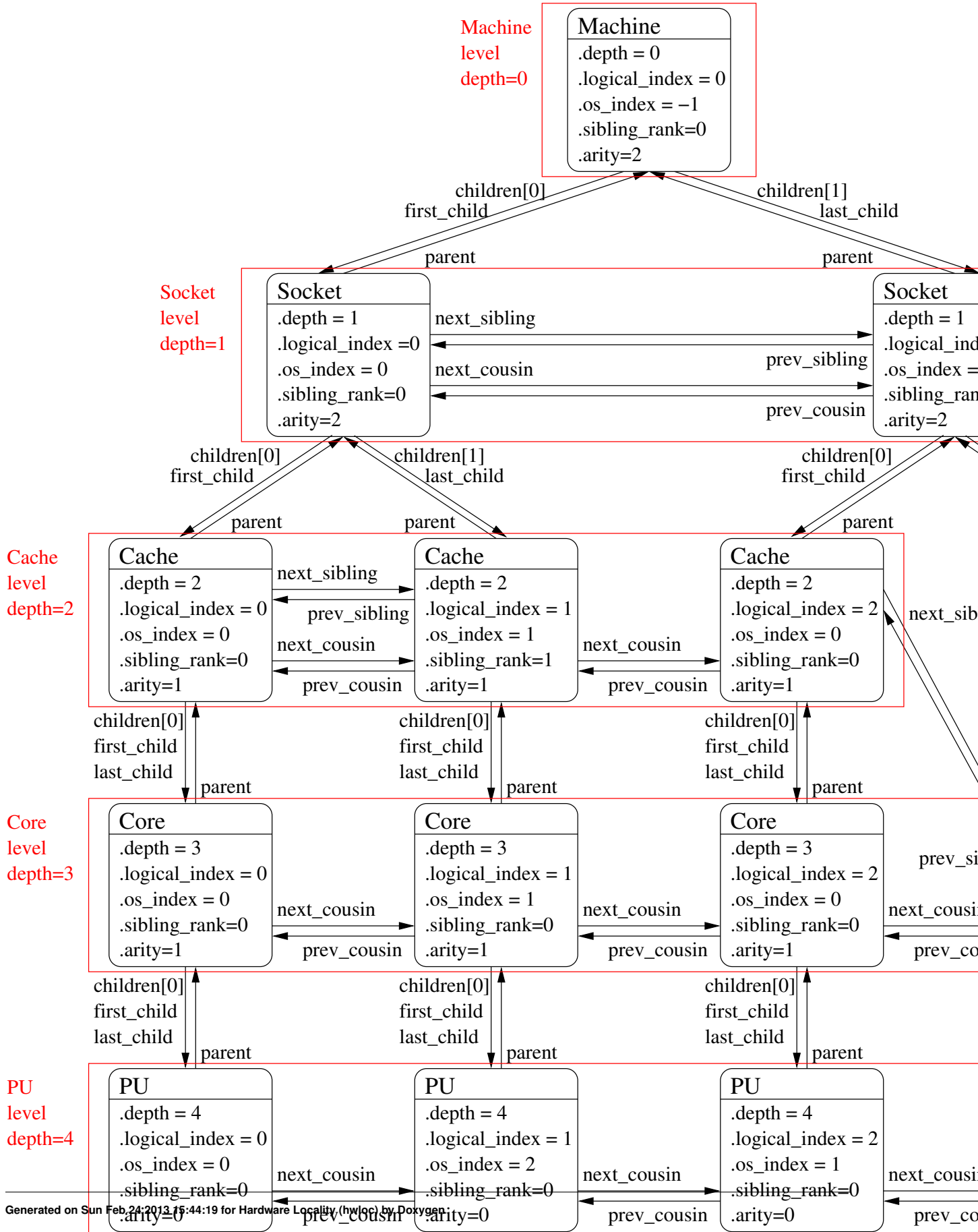

Figure 2.1: width=

It should be noted that for PU objects, the logical index – as computed linearly by hwloc – is not the same as the OS index.

See also [What happens if my topology is asymmetric?](#) for more details.

Chapter 3

Command-Line Tools

hwloc comes with an extensive C programming interface and several command line utilities. Each of them is fully documented in its own manual page; the following is a summary of the available command line tools.

3.1 lstopo

lstopo (also known as hwloc-info and hwloc-ls) displays the hierarchical topology map of the current system. The output may be graphical or textual, and can also be exported to numerous file formats such as PDF, PNG, XML, and others.

This command can also display the processes currently bound to a part of the machine (via the `-ps` option).

Note that lstopo can read XML files and/or alternate chroot filesystems and display topological maps representing those systems (e.g., use lstopo to output an XML file on one system, and then use lstopo to read in that XML file and display it on a different system).

3.2 hwloc-bind

hwloc-bind binds processes to specific hardware objects through a flexible syntax. A simple example is binding an executable to specific cores (or sockets or bitmaps or ...). The `hwloc-bind(1)` man page provides much more detail on what is possible.

hwloc-bind can also be used to retrieve the current process' binding.

3.3 hwloc-calc

hwloc-calc is generally used to create bitmap strings to pass to hwloc-bind. Although hwloc-bind accepts many forms of object specification (i.e., bitmap strings are one of many forms that hwloc-bind understands), they can be useful, compact representations in shell scripts, for example.

hwloc-calc generates bitmap strings from given hardware objects with the ability to aggregate them, intersect them, and more. hwloc-calc generally uses the same syntax than hwloc-bind, but multiple instances may be composed to generate complex combinations.

Note that hwloc-calc can also generate lists of logical processors or NUMA nodes that are convenient to pass to some external tools such as `taskset` or `numactl`.

3.4 hwloc-distrib

hwloc-distrib generates a set of bitmap strings that are uniformly distributed across the machine for the given number of processes. These strings may be used with hwloc-bind to run processes to maximize their memory bandwidth by properly distributing them across the machine.

3.5 hwloc-ps

hwloc-ps is a tool to display the bindings of processes that are currently running on the local machine. By default, hwloc-ps only lists processes that are bound; unbound process (and Linux kernel threads) are not displayed.

3.6 hwloc-gather-topology

hwloc-gather-topology is a Linux-specific tool that saves the relevant topology files of the current machine into a tarball (and the corresponding lstopo output). These files may be used later (possibly offline) for simulating or debugging a machine without actually running on it.

Chapter 4

Environment Variables

The behavior of the hwloc library and tools may be tuned thanks to the following environment variables.

HWLOC_XMLFILE=/path/to/file.xml enforces the discovery from the given XML file as if `hwloc_topology_set_xml()` had been called. This file may have been generated earlier with `lstopo file.xml`. For convenience, this backend provides empty binding hooks which just return success. To have hwloc still actually call OS-specific hooks, `HWLOC_THISSYSTEM` should be set 1 in the environment too, to assert that the loaded file is really the underlying system. See also [Importing and exporting topologies from/to XML files](#).

HWLOC_XML_VERBOSE=1 enable verbose messages in the XML or synthetic topology backends. hwloc XML backends (see [Importing and exporting topologies from/to XML files](#)) can emit some error messages to the error output stream. Enabling these verbose messages within hwloc can be useful for understanding failures to parse input XML topologies.

HWLOC_FSROOT=/path/to/linux/filesystem-root/ switches to reading the topology from the specified Linux filesystem root instead of the main file-system root, as if `hwloc_topology_set_fsroot()` had been called. Not using the main file-system root causes `hwloc_topology_is_thissystem()` to return 0. For convenience, this backend provides empty binding hooks which just return success. To have hwloc still actually call OS-specific hooks, `HWLOC_THISSYSTEM` should be set 1 in the environment too, to assert that the loaded file is really the underlying system.

HWLOC_THISSYSTEM=1 enforces the return value of `hwloc_topology_is_thissystem()`. It means that it makes hwloc assume that the selected backend provides the topology for the system on which we are running, even if it is not the OS-specific backend but the XML backend for instance. This means making the binding functions actually call the OS-specific system calls and really do binding, while the XML backend would otherwise provide empty hooks just returning success. This can be used for efficiency reasons to first detect the topology once, save it to an XML file, and quickly reload it later through the XML backend, but still having binding functions actually do bind.

HWLOC_HIDE_ERRORS=0 enables or disables verbose reporting of errors. The hwloc library may issue warnings to the standard error stream when it detects a problem during topology discovery, for instance if the operating system (or user) gives contradictory topology information. Setting this environment variable to 1 removes the actual displaying of these error messages.

HWLOC_GROUPING=1 enables or disables objects grouping based on distances. By default, hwloc uses distance matrices between objects (either read from the OS or given by the user) to find groups of close objects. These groups are described by adding intermediate Group objects in the topology. Setting this environment variable to 0 will disable this grouping. This variable supersedes the obsolete `HWLOC_IGNORE_DISTANCES` variable.

HWLOC_GROUPING_ACCURACY=0.05 relaxes distance comparison during grouping. By default, objects may be grouped if their distances form a minimal distance graph. When setting this variable to 0.02, these distances do not have to be strictly equal anymore, they may just be equal with a 2% error. If set to `try` instead of a numerical value, hwloc will try to group with perfect accuracy (0, the default), then with 0.01, 0.02, 0.05 and finally 0.1.

HWLOC_GROUPING_VERBOSE=0 enables or disables some verbose messages during grouping. If this variable is set to 1, some debug messages will be displayed during distance-based grouping of objects even if debug was not specific at configure time. This is useful when trying to find an interesting distance grouping accuracy.

HWLOC_<type>_DISTANCES=index,...:X*Y

HWLOC_<type>_DISTANCES=index,...:X*Y*Z

HWLOC_<type>_DISTANCES=index,...:distance,... sets a distance matrix for objects of the given type and physical indexes. The type should be given as its case-sensitive stringified value (e.g. `NUMANode`, `Socket`, `Cache`, `Core`, `PU`). If another distance matrix already exists for the given type, either because the user specified it or because the OS offers it, it will be replaced by the given one. If the variable value is `none`, the existing distance matrix for the given type is removed. Otherwise, the variable value starts with a comma-separated list of the objects' physical indexes. Distances are then specified after a colon.

- If `X*Y` is given, X groups of Y close objects are specified.
- If `X*Y*Z` is given, X groups of Y groups of Z close objects are specified.
- Otherwise, the comma-separated list of distances should be given. If N objects are considered, the `i*N+j`-th value gives the distance from the `i`-th object to the `j`-th object.

HWLOC_PCI_<domain>_<bus>_LOCALCPUS=<cpuset> changes the locality of I/O devices behind the specified PCI hostbridge. If no I/O locality information is available or if the BIOS reports incorrect information, it is possible to move a I/O device tree (the entire set of objects behind a host bridge) near a custom set of processors. `domain` and `bus` are the PCI domain and primary bus of the corresponding host bridge.

Chapter 5

CPU and Memory Binding Overview

Some operating systems do not systematically provide separate functions for CPU and memory binding. This means that CPU binding functions may have effects on the memory binding policy. Likewise, changing the memory binding policy may change the CPU binding of the current thread. This is often not a problem for applications, so by default hwloc will make use of these functions when they provide better binding support.

If the application does not want the CPU binding to change when changing the memory policy, it needs to use the `HWLOC_MEMBIND_NOCPUBIND` flag to prevent hwloc from using OS functions which would change the CPU binding. Additionally, `HWLOC_CPUBIND_NOMEMBIND` can be passed to CPU binding function to prevent hwloc from using OS functions would change the memory binding policy. Of course, using these flags will reduce hwloc's overall support for binding, so their use is discouraged.

One can avoid using these flags but still closely control both memory and CPU binding by allocating memory, touching each page in the allocated memory, and then changing the CPU binding. The already-really-allocated memory will then be "locked" to physical memory and will not be migrated. Thus, even if the memory binding policy gets changed by the CPU binding order, the already-allocated memory will not change with it. When binding and allocating further memory, the CPU binding should be performed again in case the memory binding altered the previously-selected CPU binding.

Not all operating systems support the notion of a "current" memory binding policy for the current process, but such operating systems often still provide a way to allocate data on a given node set. Conversely, some operating systems support the notion of a "current" memory binding policy and do not permit allocating data on a specific node set without changing the current policy and allocate the data. To provide the most powerful coverage of these facilities, hwloc provides:

- functions that set/get the current memory binding policies (if supported): `hwloc_set/get_membind_*`() and `hwloc_set/get_proc_membind()`
- functions that allocate memory bound to specific node set without changing the current memory binding policy (if supported): `hwloc_alloc_membind()` and `hwloc_alloc_membind_nodeset()`.
- helpers which, if needed, change the current memory binding policy of the process in order to obtain memory binding: `hwloc_alloc_membind_policy()` and `hwloc_alloc_membind_policy_nodeset()`

An application can thus use the two first sets of functions if it wants to manage separately the global process binding policy and directed allocation, or use the third set of functions if it does not care about the process memory binding policy.

See [CPU binding](#) and [Memory binding](#) for hwloc's API functions regarding CPU and memory binding, respectively.

Chapter 6

I/O Devices

hwloc usually manipulates processing units and memory but it can actually discover I/O devices and report their locality as well. This is useful for placing I/O intensive applications on cores near the I/O devices they use.

6.1 Enabling and requirements

I/O discovery is disabled by default (except in `lstopo`) so as not to break legacy application by adding unexpected I/O objects to the topology. It can be enabled by passing flags such as `HWLOC_TOPOLOGY_FLAG_IO_DEVICES` to `hwloc_topology_set_flags()` before loading the topology.

Note that I/O discovery requires significant help from the operating system. The `pciutils` library is needed to detect PCI devices and bridges, and the actual locality of these devices is only currently detected on Linux. Also, some operating systems require privileges for probing PCI devices, see [Does hwloc require privileged access?](#) for details.

6.2 I/O object hierarchy

When I/O discovery is enabled and supported, some additional objects (types `HWLOC_OBJ_BRIDGE`, `HWLOC_OBJ_PCI_DEVICE` and `HWLOC_OBJ_OS_DEVICE`) are added to the topology as a child of the object they are close to. For instance, if a I/O Hub is connected to a socket, the corresponding hwloc bridge object (and its PCI bridges and devices children) is inserted as a child of the corresponding hwloc socket object.

These new objects have neither CPU sets nor node sets (NULL pointers) because they are not directly usable by the user applications. Moreover I/O hierarchies may be highly complex (asymmetric trees of bridges). So I/O objects are placed in specific levels with custom depths. Their lists may still be traversed with regular helpers such as `hwloc_get_next_obj_by_type()`. However, hwloc offers some dedicated helpers such as `hwloc_get_next_pcidev()` and `hwloc_get_next_osdev()` for convenience (see [Advanced I/O object traversal helpers](#)).

An I/O hierarchy is organized as follows: A hostbridge object (`HWLOC_OBJ_BRIDGE` object with upstream type *Host* and downstream type *PCI*) is attached below a regular object (usually the entire machine or a NUMA node). There may be multiple hostbridges in the machine, attached to different places, but all I/O devices are below one of them. Each hostbridge contains one or several children, either other bridges (usually PCI to PCI) or PCI devices (`HWLOC_OBJ_PCI_DEVICE`). The number of bridges between the hostbridge and a PCI device depends on the machine and on the topology flags.

6.3 Software devices

Although each PCI device is uniquely identified by its bus ID (e.g. 0000:01:02.3), the application can hardly find out which PCI device is actually used when manipulating software handle (such as the *eth0* network interface or the *mlx4_0* OpenFabrics HCA). Therefore hwloc tries to add software devices (`HWLOC_OBJ_OS_DEVICE`) below their PCI objects. These objects can be identified by their usual operating system-wide names, e.g. *eth0* or *mlx4_0*. However, this ability is currently only available on Linux for some classes of devices. It should especially be noted that proprietary graphics driver currently do not create any interesting software device for GPUs, they should therefore be manipulated as PCI device objects. On the contrary some PCI devices may contain multiple software device (see the example below).

See also [Interoperability With Other Software](#) for managing these devices without considering them as hwloc objects.

6.4 Consulting I/O devices and binding

I/O devices may be consulted by traversing the topology manually (with usual routines such as `hwloc_get_obj_by_type()`) or by using dedicated helpers (such as `hwloc_get_pcidev_by_busid()`, see [Advanced I/O object traversal helpers](#)).

I/O objects do not actually contain any locality information because their CPU sets and node sets are NULL. Their locality must be retrieved by walking up the object tree (through the `parent` link) until a non-I/O object is found (see `hwloc_get_non_io_ancestor_obj()`). This regular object should have non-NULL CPU sets and node sets which describe the processing units and memory that are immediately close to the I/O device. For instance the path from a OS device to its locality may go across a PCI device parent, one or several bridges, up to a NUMA node with the same locality.

Command-line tools are also aware of I/O devices. `Istopo` displays the interesting ones by default (passing `-no-io` disables it).

`hwloc-calc` and `hwloc-bind` may manipulate I/O devices specified by PCI bus ID or by OS device name. For instance, `pci=0000:02:03.0` (respectively `os=eth0`) is replaced by the set of CPUs that are close to this PCI device (respectively software device). This enables easy binding of I/O-intensive applications near the device they use.

6.5 Examples

The following picture shows a dual-socket dual-core host whose PCI bus is connected to the first socket and NUMA node.

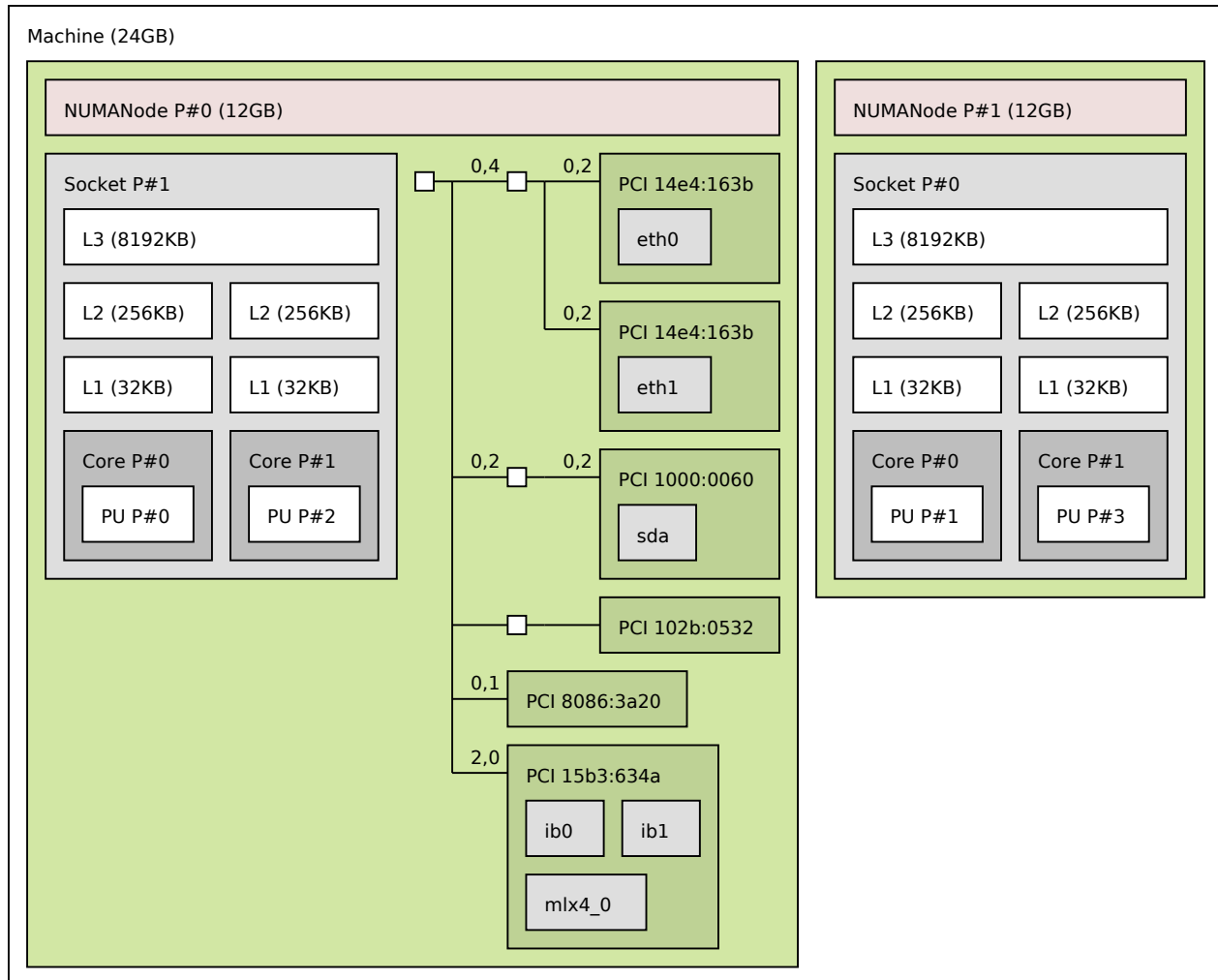

Six interesting PCI devices were discovered. However hwloc found some corresponding software devices (*eth0*, *eth1*, *sda*, *mlx4_0*, *ib0*, and *ib1*) for only four of these physical devices. The other ones (*PCI 102b:0532* and *PCI 8086:3a20*) are an unused IDE controller (no disk attached) and a graphic card (no corresponding software device reported to the user by the operating system).

On the contrary, it should be noted three different software devices were found for the last PCI device (*PCI 15b3:634a*). Indeed this OpenFabrics HCA PCI device object contains one one OpenFabrics software device (*mlx4_0*) and two virtual network interface software devices (*ib0* and *ib1*).

PCI link speed is also reported for some bridges and devices because lstopo was privileged when it discovered the topology.

Here is the corresponding textual output:

```
Machine (24GB)
  NUMANode L#0 (P#0 12GB)
    Socket L#0 + L3 L#0 (8192KB)
      L2 L#0 (256KB) + L1 L#0 (32KB) + Core L#0 + PU L#0 (P#0)
      L2 L#1 (256KB) + L1 L#1 (32KB) + Core L#1 + PU L#1 (P#2)
    HostBridge
      PCIBridge
        PCI 14e4:163b
          Net "eth0"
        PCI 14e4:163b
          Net "eth1"
```

```
PCIBridge
  PCI 1000:0060
    Block "sda"
PCIBridge
  PCI 102b:0532
  PCI 8086:3a20
  PCI 15b3:634a
  Net "ib0"
  Net "ib1"
  Net "mlx4_0"
NUMANode L#1 (P#1 12GB) + Socket L#1 + L3 L#1 (8192KB)
  L2 L#2 (256KB) + L1 L#2 (32KB) + Core L#2 + PU L#2 (P#1)
  L2 L#3 (256KB) + L1 L#3 (32KB) + Core L#3 + PU L#3 (P#3)
```

Chapter 7

Importing and exporting topologies from/to XML files

hwloc offers the ability to export topologies to XML files and reload them later. This is for instance useful for loading topologies faster (see [I do not want hwloc to rediscover my enormous machine topology every time I rerun a process](#)), manipulating other nodes' topology, or avoiding the need for privileged processes (see [Does hwloc require privileged access?](#)).

Topologies may be exported to XML files thanks to `hwloc_topology_export_xml()`, or to a XML memory buffer with `hwloc_topology_export_xmlbuffer()`. The `lstopo` program can also serve as a XML topology export tool.

XML topologies may then be reloaded later with `hwloc_topology_set_xml()` and `hwloc_topology_set_xmlbuffer()`. The `XMLFILE` environment variable also tells hwloc to load the topology from the given XML file.

7.1 libxml2 and minimalistic XML backends

hwloc offers two backends for importing/exporting XML.

First, it can use the `libxml2` library for importing/exporting XML files. It features full XML support, for instance when those files have to be manipulated by non-hwloc software (e.g. a XSLT parser). The `libxml2` backend is enabled by default if `libxml2` development headers are available.

If `libxml2` is not available at configure time, or if `-disable-libxml2` is passed, hwloc falls back to a custom backend. Contrary to the aforementioned full XML backend with `libxml2`, this minimalistic XML backend cannot be guaranteed to work with external programs. It should only be assumed to be compatible with the same hwloc release (even if using the `libxml2` backend). Its advantage is however to always be available without requiring any external dependency.

7.2 XML import error management

Importing XML files can fail at least because of file access errors, invalid XML syntax or non-hwloc-valid XML contents.

Both backend cannot detect all these errors when the input XML file or buffer is selected (when `hwloc_topology_set_xml()` or `hwloc_topology_set_xmlbuffer()` is called). Some errors such non-hwloc-valid contents can only be detected later when loading the topology with `hwloc_topology_load()`.

It is therefore strongly recommended to check the return value of both `hwloc_topology_set_xml()` (or `hwloc_topology_set_xmlbuffer()`) and `hwloc_topology_load()` to handle all these errors.

Chapter 8

Interoperability With Other Software

Although hwloc offers its own portable interface, it still may have to interoperate with specific or non-portable libraries that manipulate similar kinds of objects. hwloc therefore offers several specific "helpers" to assist converting between those specific interfaces and hwloc.

Some external libraries may be specific to a particular OS; others may not always be available. The hwloc core therefore generally does not explicitly depend on these types of libraries. However, when a custom application uses or otherwise depends on such a library, it may optionally include the corresponding hwloc helper to extend the hwloc interface with dedicated helpers.

Linux specific features [hwloc/linux.h](#) offers Linux-specific helpers that utilize some non-portable features of the Linux system, such as binding threads through their thread ID ("tid") or parsing kernel CPU mask files.

Linux libnuma [hwloc/linux-libnuma.h](#) provides conversion helpers between hwloc CPU sets and libnuma-specific types, such as nodemasks and bitmasks. It helps you use libnuma memory-binding functions with hwloc CPU sets.

Glibc [hwloc/glibc-sched.h](#) offers conversion routines between Glibc and hwloc CPU sets in order to use hwloc with functions such as `sched_setaffinity()`.

OpenFabrics Verbs [hwloc/openfabrics-verbs.h](#) helps interoperability with the OpenFabrics Verbs interface. For example, it can return a list of processors near an OpenFabrics device. Note that if I/O device discovery is enabled, such devices may also appear as PCI objects and as OS objects in the topology.

Myrinet Express [hwloc/myriexpress.h](#) offers interoperability with the Myrinet Express interface. It can return the list of processors near a Myrinet board managed by the MX driver. Note that if I/O device discovery is enabled, such boards may also appear as PCI objects in the topology.

NVIDIA CUDA [hwloc/cuda.h](#) and [hwloc/cudart.h](#) enable interoperability with NVIDIA CUDA Driver and Runtime interfaces. For instance, it may return the list of processors near NVIDIA GPUs. Note that if I/O device discovery is enabled, GPUs may also appear as PCI objects in the topology.

Taskset command-line tool The taskset command-line tool is widely used for binding processes. It manipulates CPU set strings in a format that is slightly different from hwloc's one (it does not divide the string in fixed-size subsets and separates them with commas). To ease interoperability, hwloc offers routines to convert hwloc CPU sets from/to taskset-specific string format. Most hwloc command-line tools also support the `-taskset` option to manipulate taskset-specific strings.

Chapter 9

Thread Safety

Like most libraries that mainly fill data structures, hwloc is not thread safe but rather reentrant: all state is held in a `hwloc_topology_t` instance without mutex protection. That means, for example, that two threads can safely operate on and modify two different `hwloc_topology_t` instances, but they should not simultaneously invoke functions that modify the *same* instance. Similarly, one thread should not modify a `hwloc_topology_t` instance while another thread is reading or traversing it. However, two threads can safely read or traverse the same `hwloc_topology_t` instance concurrently.

When running in multiprocessor environments, be aware that proper thread synchronization and/or memory coherency protection is needed to pass hwloc data (such as `hwloc_topology_t` pointers) from one processor to another (e.g., a mutex, semaphore, or a memory barrier). Note that this is not a hwloc-specific requirement, but it is worth mentioning.

For reference, `hwloc_topology_t` modification operations include (but may not be limited to):

Creation and destruction `hwloc_topology_init()`, `hwloc_topology_load()`, `hwloc_topology_destroy()` (see [Create and Destroy Topologies](#)) imply major modifications of the structure, including freeing some objects. No other thread cannot access the topology or any of its objects at the same time.

Also references to objects inside the topology are not valid anymore after these functions return.

Runtime topology modifications `hwloc_topology_insert_misc_object_by_*` (see [Tinker With Topologies](#).) may modify the topology significantly by adding objects inside the tree, changing the topology depth, etc. `hwloc_topology_restrict` modifies the topology even more dramatically by removing some objects.

Although references to former objects *may* still be valid after insertion or restriction, it is strongly advised to not rely on any such guarantee and always re-consult the topology to reacquire new instances of objects.

Locating topologies `hwloc_topology_ignore*`, `hwloc_topology_set*` (see [Configure Topology Detection](#)) do not modify the topology directly, but they do modify internal structures describing the behavior of the next invocation of `hwloc_topology_load()`. Hence, all of these functions should not be used concurrently.

Note that these functions do not modify the current topology until it is actually reloaded; it is possible to use them while other threads are only read the current topology.

Chapter 10

Embedding hwloc in Other Software

It can be desirable to include hwloc in a larger software package (be sure to check out the LICENSE file) so that users don't have to separately download and install it before installing your software. This can be advantageous to ensure that your software uses a known-tested/good version of hwloc, or for use on systems that do not have hwloc pre-installed.

When used in "embedded" mode, hwloc will:

- not install any header files
- not build any documentation files
- not build or install any executables or tests
- not build `libhwloc.*` – instead, it will build `libhwloc_embedded.*`

There are two ways to put hwloc into "embedded" mode. The first is directly from the configure command line:

```
shell$ ./configure --enable-embedded-mode ...
```

The second requires that your software project uses the GNU Autoconf / Automake / Libtool tool chain to build your software. If you do this, you can directly integrate hwloc's m4 configure macro into your configure script. You can then invoke hwloc's configuration tests and build setup by calling an m4 macro (see below).

10.1 Using hwloc's M4 Embedding Capabilities

Every project is different, and there are many different ways of integrating hwloc into yours. What follows is *one* example of how to do it.

If your project uses recent versions Autoconf, Automake, and Libtool to build, you can use hwloc's embedded m4 capabilities. We have tested the embedded m4 with projects that use Autoconf 2.65, Automake 1.11.1, and Libtool 2.2.6b. Slightly earlier versions of may also work but are untested. Autoconf versions prior to 2.65 are almost certain to not work.

You can either copy all the config/hwloc*m4 files from the hwloc source tree to the directory where your project's m4 files reside, or you can tell aclocal to find more m4 files in the embedded hwloc's "config" subdirectory (e.g., add "--lpath/to/embedded/hwloc/config" to your Makefile.am's ACLOCAL_AMFLAGS).

The following macros can then be used from your configure script (only `HWLOC_SETUP_CORE` *must* be invoked if using the m4 macros):

- `HWLOC_SETUP_CORE`(`config-dir-prefix`, `action-upon-success`, `action-upon-failure`, `print_banner_or_not`): Invoke the hwloc configuration tests and setup the hwloc tree to build. The first argument is the prefix to use for `AC_OUTPUT` files – it's where the hwloc tree is located relative to `$top_srcdir`. Hence, if your embedded hwloc is located in the source tree at `contrib/hwloc`, you should pass `[contrib/hwloc]` as the first argument. If `HWLOC_SETUP_CORE` and the rest of `configure` completes successfully, then "make" traversals of the hwloc tree with standard Automake targets (all, clean, install, etc.) should behave as expected. For example, it is safe to list the hwloc directory in the `SUBDIRS` of a higher-level `Makefile.am`. The last argument, if not empty, will cause the macro to display an announcement banner that it is starting the hwloc core configuration tests.

`HWLOC_SETUP_CORE` will set the following environment variables and `AC_SUBST` them: `HWLOC_EMBEDDED_CFLAGS`, `HWLOC_EMBEDDED_CPPFLAGS`, and `HWLOC_EMBEDDED_LIBS`. These flags are filled with the values discovered in the hwloc-specific m4 tests, and can be used in your build process as relevant. The `_CFLAGS`, `_CPPFLAGS`, and `_LIBS` variables are necessary to build `libhwloc` (or `libhwloc_embedded`) itself.

`HWLOC_SETUP_CORE` also sets `HWLOC_EMBEDDED_LDADD` environment variable (and `AC_SUBST`s it) to contain the location of the `libhwloc_embedded.la` convenience Libtool archive. It can be used in your build process to link an application or other library against the embedded hwloc library.

NOTE: If the `HWLOC_SET_SYMBOL_PREFIX` macro is used, it must be invoked *before* `HWLOC_SETUP_CORE`.

- `HWLOC_BUILD_STANDALONE`: `HWLOC_SETUP_CORE` defaults to building hwloc in an "embedded" mode (described above). If `HWLOC_BUILD_STANDALONE` is invoked **before** `HWLOC_SETUP_CORE`, the embedded definitions will not apply (e.g., `libhwloc.la` will be built, not `libhwloc_embedded.la`).
- `HWLOC_SET_SYMBOL_PREFIX`(`foo_`): Tells the hwloc to prefix all of hwloc's types and public symbols with "foo_"; meaning that function `hwloc_init()` becomes `foo_hwloc_init()`. Enum values are prefixed with an uppercase translation if the prefix supplied; `HWLOC_OBJ_SYSTEM` becomes `FOO_HWLOC_OBJ_SYSTEM`. This is recommended behavior if you are including hwloc in middleware – it is possible that your software will be combined with other software that links to another copy of hwloc. If both uses of hwloc utilize different symbol prefixes, there will be no type/symbol clashes, and everything will compile, link, and run successfully. If you both embed hwloc without changing the symbol prefix and also link against an external hwloc, you may get multiple symbol definitions when linking your final library or application.
- `HWLOC_SETUP_DOCS`, `HWLOC_SETUP_UTILS`, `HWLOC_SETUP_TESTS`: These three macros only apply when hwloc is built in "standalone" mode (i.e., they should NOT be invoked unless `HWLOC_BUILD_STANDALONE` has already been invoked).
- `HWLOC_DO_AM_CONDITIONALS`: If you embed hwloc in a larger project and build it conditionally with Automake (e.g., if `HWLOC_SETUP_CORE` is invoked conditionally), you must unconditionally invoke `HWLOC_DO_AM_CONDITIONALS` to avoid warnings from Automake (for the cases where hwloc is not selected to be built). This macro is necessary because hwloc uses some `AM_CONDITIONALS` to build itself, and `AM_CONDITIONALS` cannot be defined conditionally. Note that it is safe (but unnecessary) to call `HWLOC_DO_AM_CONDITIONALS` even if `HWLOC_SETUP_CORE` is invoked unconditionally. If you are not using Automake to build hwloc, this macro is unnecessary (and will actually cause errors because it invoked `AM_*` macros that will be undefined).

NOTE: When using the `HWLOC_SETUP_CORE` m4 macro, it may be necessary to explicitly invoke `AC_CANONICAL_TARGET` (which requires `config.sub` and `config.guess`) and/or `AC_USE_SYSTEM_EXTENSIONS` macros early in the `configure` script (e.g., after `AC_INIT` but before `AM_INIT_AUTOMAKE`). See the Autoconf documentation for further information.

Also note that hwloc's top-level `configure.ac` script uses exactly the macros described above to build hwloc in a standalone mode (by default). You may want to examine it for one example of how these macros are used.

10.2 Example Embedding hwloc

Here's an example of integrating with a larger project named `sandbox` that already uses Autoconf, Automake, and Libtool to build itself:

```
# First, cd into the sandbox project source tree
shell$ cd sandbox
shell$ cp -r /somewhere/else/hwloc-<version> my-embedded-hwloc
shell$ edit Makefile.am
  1. Add "-Imy-embedded-hwloc/config" to ACLOCAL_AMFLAGS
  2. Add "my-embedded-hwloc" to SUBDIRS
  3. Add "$(HWLOC_EMBEDDED_LDADD)" and "$(HWLOC_EMBEDDED_LIBS)" to
    sandbox's executable's LDADD line. The former is the name of the
    Libtool convenience library that hwloc will generate. The latter
    is any dependent support libraries that may be needed by
    $(HWLOC_EMBEDDED_LDADD).
  4. Add "$(HWLOC_EMBEDDED_CFLAGS)" to AM_CFLAGS
  5. Add "$(HWLOC_EMBEDDED_CPPFLAGS)" to AM_CPPFLAGS
shell$ edit configure.ac
  1. Add "HWLOC_SET_SYMBOL_PREFIX(sandbox_hwloc_)" line
  2. Add "HWLOC_SETUP_CORE([my-embedded-hwloc], [happy=yes], [happy=no])" line
  3. Add error checking for happy=no case
shell$ edit sandbox.c
  1. Add #include <hwloc.h>
  2. Add calls to sandbox_hwloc_init() and other hwloc API functions
```

Now you can bootstrap, configure, build, and run the `sandbox` as normal – all calls to `"sandbox_hwloc_*`" will use the embedded hwloc rather than any system-provided copy of hwloc.

Chapter 11

Frequently Asked Questions

11.1 I do not want hwloc to rediscover my enormous machine topology every time I rerun a process

Although the topology discovery is not expensive on common machines, its overhead may become significant when multiple processes repeat the discovery on large machines (for instance when starting one process per core in a parallel application). The machine topology usually does not vary much, except if some cores are stopped/restarted or if the administrator restrictions are modified. Thus rediscovering the whole topology again and again may look useless.

For this purpose, hwloc offers XML import/export features. It lets you save the discovered topology to a file (for instance with the `lstopo` program) and reload it later by setting the `HWLOC_XMLFILE` environment variable. Loading a XML topology is usually much faster than querying multiple files or calling multiple functions of the operating system. It is also possible to manipulate such XML files with the C programming interface, and the import/export may also be directed to memory buffer (that may for instance be transmitted between applications through a socket). See also [Importing and exporting topologies from/to XML files](#).

11.2 Does hwloc require privileged access?

hwloc discovers the topology by querying the operating system. Some minor features may require privileged access to the operation system. For instance PCI link speed discovery on Linux is reserved to root, and the entire PCI discovery on FreeBSD requires access to the `/dev/pci` special file.

To workaround this limitation, it is recommended to export the topology as a XML file generated by the administrator (with the `lstopo` program) and make it available to all users (see [Importing and exporting topologies from/to XML files](#)). It will offer all discovery information to any application without requiring any privileged access anymore. Only the necessary hardware characteristics will be exported, no sensitive information will be disclosed through this XML export.

This XML-based model also has the advantage of speeding up the discovery because reading a XML topology is usually much faster than querying the operating system again.

11.3 hwloc only has a one-dimensional view of the architecture, it ignores distances

hwloc places all objects in a tree. Each level is a one-dimensional view of a set of similar objects. All children of the same object (siblings) are assumed to be equally interconnected (same distance between any of them), while the distance between children of different objects (cousins) is supposed to be larger.

Modern machines exhibit complex hardware interconnects, so this tree may miss some information about the actual physical distances between objects. The hwloc topology may therefore be annotated with distance information that may be used to build a more realistic representation (multi-dimensional) of each level. For instance, the root object may contain a distance matrix that represents the latencies between any pairs of NUMA nodes if the BIOS and/or operating system reports them.

11.4 How may I ignore symmetric multithreading, hyper-threading, ... ?

hwloc creates one PU (processing unit) object per hardware thread. If your machine supports symmetric multithreading, for instance Hyper-Threading, each Core object may contain multiple PU objects.

```
$ lstopo -
...
Core L#1
  PU L#2 (P#1)
  PU L#3 (P#3)
```

If you need to ignore symmetric multithreading, you should likely manipulate hwloc Core objects directly:

```
/* get the number of cores */
unsigned nbcores = hwloc_get_nbobjs_by_type(topology, HWLOC_OBJ_CORE);
...
/* get the third core below the first socket */
hwloc_obj_t socket, core;
socket = hwloc_get_obj_by_type(topology, HWLOC_OBJ_SOCKET, 0);
core = hwloc_get_obj_inside_cpuset_by_type(topology, socket->cpuset,
                                           HWLOC_OBJ_CORE, 2);
```

Whenever you want to bind a process or thread to a core, make sure you simplify its cpuset first, so that the task is actually bound to a single thread within this core (to avoid useless migrations).

```
/* bind on the second core */
hwloc_obj_t core = hwloc_get_obj_by_type(topology, HWLOC_OBJ_CORE, 1);
hwloc_cpuset_t set = hwloc_bitmap_dup(core->cpuset);
hwloc_bitmap_singlify(set);
hwloc_set_cpubind(topology, set, 0);
hwloc_bitmap_free(set);
```

With hwloc-calc or hwloc-bind command-line tools, you may specify that you only want a single-thread within each core by asking for their first PU object:

```
$ hwloc-calc core:4-7
0x0000ff00
$ hwloc-calc core:4-7.pu:0
0x00005500
```

When binding a process on the command-line, you may either specify the exact thread that you want to use, or ask hwloc-bind to simplify the cpuset before binding

```
$ hwloc-bind core:3.pu:0 -- echo "hello from first thread on core #3"
hello from first thread on core #3
...
$ hwloc-bind core:3 --single -- echo "hello from a single thread on core #3"
hello from a single thread on core #3
```

11.5 What happens if my topology is asymmetric?

hwloc supports asymmetric topologies even if most platforms are usually symmetric. For example, there may be different types of processors in a single machine, each with different numbers of cores, symmetric multithreading, or levels of caches.

To understand how hwloc manages such cases, one should first remember the meaning of levels and cousin objects. All objects of the same type are gathered as horizontal levels with a given depth. They are also connected through the cousin pointers of the `hwloc_obj` structure. Some types, such as Caches or Groups, are usually annotated with a depth or level attribute (for instance L2 cache). In this case, this attribute is also taken in account when gathering objects as horizontal levels. To be clear: there will be one level for L1 caches, another level for L2 caches, etc.

If the topology is asymmetric (e.g., if a cache is missing in one of the processors), a given horizontal level will still exist if there exist any objects of that type. However, some branches of the overall tree may not have an object located in that horizontal level. Note that this specific hole within one horizontal level does not imply anything for other levels. All objects of the same type are gathered in horizontal levels even if their parents or children have different depths and types.

Moreover, it is important to understand that a same parent object may have children of different types (and therefore, different depths). **These children are therefore siblings (because they have the same parent), but they are *not* cousins (because they do not belong to the same horizontal levels).**

11.6 How do I annotate the topology with private notes?

Each hwloc object contains a `userdata` field that may be used by applications to store private pointers. This field is kept intact as long as the object is valid, which means as long as topology objects are not modified by reloading or restricting the topology.

Each object may also contain some `info` attributes (key name and value) that are setup by hwloc and may be extended by the user with `hwloc_obj_add_info()`. Contrary to the `userdata` field which is unique, multiple `info` attributes may exist for each object, even with the same name. These attributes are also exported to XML together with the topology. However only character strings may be used as key names and values.

It is also possible to insert Misc objects with custom names anywhere in the topology (`hwloc_topology_insert_misc_object_by_cpuset()`) or as a leaf of the topology (`hwloc_topology_insert_misc_object_by_parent()`).

11.7 How do I handle API upgrades?

The hwloc interface is extended with every new major release. Any application using the hwloc API should be prepared to check at compile-time whether some features are available in the currently installed hwloc distribution.

To check whether hwloc is at least 1.2, you should use:

```
#include <hwloc.h>
#if HWLOC_API_VERSION >= 0x00010200
...
#endif
```

One of the major changes in hwloc 1.1 was the addition of the bitmap API. It supersedes the now deprecated `cpuset` API which will be removed in a future hwloc release. It is strongly recommended to switch existing codes to the bitmap API. Keeping support for older hwloc versions is easy. For instance, if your code uses `hwloc_cpuset_alloc`, you should use `hwloc_bitmap_alloc` instead and add the following code to one of your common headers:

```
#include <hwloc.h>
#if HWLOC_API_VERSION < 0x00010100
#define hwloc_bitmap_alloc hwloc_cpuset_alloc
#endif
```

Similarly, the hwloc 1.0 interface may be detected by comparing `HWLOC_API_VERSION` with `0x00010000`.

hwloc 0.9 did not define any `HWLOC_API_VERSION` but this very old release probably does not deserve support from your application anymore.

Chapter 12

Module Index

12.1 Modules

Here is a list of all modules:

API version	49
Topology context	50
Object sets (hwloc_cpuset_t and hwloc_nodeset_t)	51
Topology Object Types	52
Topology Objects	55
Create and Destroy Topologies	56
Configure Topology Detection	58
Tinker With Topologies.	62
Get Some Topology Information	65
Retrieve Objects	67
Object/String Conversion	68
CPU binding	71
Memory binding	75
Object Type Helpers	83
Basic Traversal Helpers	84
Finding Objects Inside a CPU set	86
Finding a single Object covering at least CPU set	88
Finding a set of similar Objects covering at least a CPU set	89
Cache-specific Finding Helpers	90
Advanced Traversal Helpers	91
Binding Helpers	93
Cpuset Helpers	94
Nodeset Helpers	96
Conversion between cpuset and nodeset	98
Distances	100
Advanced I/O object traversal helpers	102
The bitmap API	104
Helpers for manipulating glibc sched affinity	112
Linux-only helpers	113
Helpers for manipulating Linux libnuma unsigned long masks	114
Helpers for manipulating Linux libnuma bitmask	116
Helpers for manipulating Linux libnuma nodemask_t	118
CUDA Driver API Specific Functions	119
CUDA Runtime API Specific Functions	120

OpenFabrics-Specific Functions	121
Myrinet Express-Specific Functions	122

Chapter 13

Data Structure Index

13.1 Data Structures

Here are the data structures with brief descriptions:

hwloc_obj_attr_u::hwloc_bridge_attr_s	
Bridge specific Object Attributes	123
hwloc_obj_attr_u::hwloc_cache_attr_s	
Cache-specific Object Attributes	124
hwloc_distances_s	
Distances between objects	125
hwloc_obj_attr_u::hwloc_group_attr_s	
Group-specific Object Attributes	126
hwloc_obj	
Structure of a topology object	126
hwloc_obj_attr_u	
Object type-specific Attributes	131
hwloc_obj_info_s	
Object info	132
hwloc_obj_memory_s::hwloc_obj_memory_page_type_s	
Array of local memory page types, NULL if no local memory and page_types is 0	133
hwloc_obj_memory_s	
Object memory	133
hwloc_obj_attr_u::hwloc_osdev_attr_s	
OS Device specific Object Attributes	134
hwloc_obj_attr_u::hwloc_pcidev_attr_s	
PCI Device specific Object Attributes	135
hwloc_topology_cpupbind_support	
Flags describing actual PU binding support for this topology	136
hwloc_topology_discovery_support	
Flags describing actual discovery support for this topology	137
hwloc_topology_membind_support	
Flags describing actual memory binding support for this topology	138
hwloc_topology_support	
Set of flags describing actual support for this topology	140

Chapter 14

Module Documentation

14.1 API version

Macros

- `#define HWLOC_API_VERSION 0x00010300`

Functions

- `HWLOC_DECLSPEC unsigned hwloc_get_api_version (void)`

14.1.1 Detailed Description

14.1.2 Macro Definition Documentation

14.1.2.1 `#define HWLOC_API_VERSION 0x00010300`

Indicate at build time which hwloc API version is being used.

14.1.3 Function Documentation

14.1.3.1 `HWLOC_DECLSPEC unsigned hwloc_get_api_version (void)`

Indicate at runtime which hwloc API version was used at build time.

14.2 Topology context

Typedefs

- typedef struct hwloc_topology * [hwloc_topology_t](#)

14.2.1 Detailed Description

14.2.2 Typedef Documentation

14.2.2.1 typedef struct hwloc_topology* [hwloc_topology_t](#)

Topology context.

To be initialized with [hwloc_topology_init\(\)](#) and built with [hwloc_topology_load\(\)](#).

14.3 Object sets (`hwloc_cpuset_t` and `hwloc_nodese_t`)

Typedefs

- typedef `hwloc_bitmap_t` `hwloc_cpuset_t`
- typedef `hwloc_const_bitmap_t` `hwloc_const_cpuset_t`
- typedef `hwloc_bitmap_t` `hwloc_nodese_t`
- typedef `hwloc_const_bitmap_t` `hwloc_const_nodese_t`

14.3.1 Detailed Description

Hwloc uses bitmaps to represent two distinct kinds of object sets: CPU sets (`hwloc_cpuset_t`) and NUMA node sets (`hwloc_nodese_t`). These types are both typedefs to a common back end type (`hwloc_bitmap_t`), and therefore all the hwloc bitmap functions are applicable to both `hwloc_cpuset_t` and `hwloc_nodese_t` (see [The bitmap API](#)).

The rationale for having two different types is that even though the actions one wants to perform on these types are the same (e.g., enable and disable individual items in the set/mask), they're used in very different contexts: one for specifying which processors to use and one for specifying which NUMA nodes to use. Hence, the name difference is really just to reflect the intent of where the type is used.

14.3.2 Typedef Documentation

14.3.2.1 typedef `hwloc_const_bitmap_t` `hwloc_const_cpuset_t`

A non-modifiable `hwloc_cpuset_t`.

14.3.2.2 typedef `hwloc_const_bitmap_t` `hwloc_const_nodese_t`

A non-modifiable `hwloc_nodese_t`.

14.3.2.3 typedef `hwloc_bitmap_t` `hwloc_cpuset_t`

A CPU set is a bitmap whose bits are set according to CPU physical OS indexes.

It may be consulted and modified with the bitmap API as any `hwloc_bitmap_t` (see [hwloc/bitmap.h](#)).

14.3.2.4 typedef `hwloc_bitmap_t` `hwloc_nodese_t`

A node set is a bitmap whose bits are set according to NUMA memory node physical OS indexes.

It may be consulted and modified with the bitmap API as any `hwloc_bitmap_t` (see [hwloc/bitmap.h](#)).

When binding memory on a system without any NUMA node (when the whole memory is considered as a single memory bank), the nodeset may be either empty (no memory selected) or full (whole system memory selected).

See also [Conversion between cpuset and nodeset](#).

14.4 Topology Object Types

Typedefs

- typedef enum [hwloc_obj_bridge_type_e](#) [hwloc_obj_bridge_type_t](#)
- typedef enum [hwloc_obj_osdev_type_e](#) [hwloc_obj_osdev_type_t](#)

Enumerations

- enum [hwloc_obj_type_t](#) { [HWLOC_OBJ_SYSTEM](#), [HWLOC_OBJ_MACHINE](#), [HWLOC_OBJ_NODE](#), [HWLOC_OBJ_SOCKET](#), [HWLOC_OBJ_CACHE](#), [HWLOC_OBJ_CORE](#), [HWLOC_OBJ_PU](#), [HWLOC_OBJ_GROUP](#), [HWLOC_OBJ_MISC](#), [HWLOC_OBJ_BRIDGE](#), [HWLOC_OBJ_PCI_DEVICE](#), [HWLOC_OBJ_OS_DEVICE](#), [HWLOC_OBJ_TYPE_MAX](#) }
- enum [hwloc_obj_bridge_type_e](#) { [HWLOC_OBJ_BRIDGE_HOST](#), [HWLOC_OBJ_BRIDGE_PCI](#) }
- enum [hwloc_obj_osdev_type_e](#) { [HWLOC_OBJ_OSDEV_BLOCK](#), [HWLOC_OBJ_OSDEV_GPU](#), [HWLOC_OBJ_OSDEV_NETWORK](#), [HWLOC_OBJ_OSDEV_OPENFABRICS](#), [HWLOC_OBJ_OSDEV_DMA](#) }
- enum [hwloc_compare_types_e](#) { [HWLOC_TYPE_UNORDERED](#) }

Functions

- [HWLOC_DECLSPEC](#) int [hwloc_compare_types](#) ([hwloc_obj_type_t](#) type1, [hwloc_obj_type_t](#) type2) [__hwloc__attribute__\(\(const\)\)](#)

14.4.1 Detailed Description

14.4.2 Typedef Documentation

14.4.2.1 typedef enum [hwloc_obj_bridge_type_e](#) [hwloc_obj_bridge_type_t](#)

Type of one side (upstream or downstream) of an I/O bridge.

14.4.2.2 typedef enum [hwloc_obj_osdev_type_e](#) [hwloc_obj_osdev_type_t](#)

Type of a OS device.

14.4.3 Enumeration Type Documentation

14.4.3.1 enum [hwloc_compare_types_e](#)

Enumerator

HWLOC_TYPE_UNORDERED Value returned by [hwloc_compare_types](#) when types can not be compared.

14.4.3.2 enum hwloc_obj_bridge_type_e

Type of one side (upstream or downstream) of an I/O bridge.

Enumerator

HWLOC_OBJ_BRIDGE_HOST Host-side of a bridge, only possible upstream.

HWLOC_OBJ_BRIDGE_PCI PCI-side of a bridge.

14.4.3.3 enum hwloc_obj_osdev_type_e

Type of a OS device.

Enumerator

HWLOC_OBJ_OSDEV_BLOCK Operating system block device. For instance "sda" on Linux.

HWLOC_OBJ_OSDEV_GPU Operating system GPU device. For instance the "card0" DRM device on Linux.

HWLOC_OBJ_OSDEV_NETWORK Operating system network device. For instance the "eth0" interface on Linux.

HWLOC_OBJ_OSDEV_OPENFABRICS Operating system openfabrics device. For instance the "mlx4_0" Infini-Band HCA device on Linux.

HWLOC_OBJ_OSDEV_DMA Operating system dma engine device. For instance the "dma0chan0" DMA channel on Linux.

14.4.3.4 enum hwloc_obj_type_t

Type of topology object.

Note

Do not rely on the ordering or completeness of the values as new ones may be defined in the future! If you need to compare types, use [hwloc_compare_types\(\)](#) instead.

Enumerator

HWLOC_OBJ_SYSTEM Whole system (may be a cluster of machines). The whole system that is accessible to hwloc. That may comprise several machines in SSI systems like Kerrighed.

HWLOC_OBJ_MACHINE Machine. The typical root object type. A set of processors and memory with cache coherency.

HWLOC_OBJ_NODE NUMA node. A set of processors around memory which the processors can directly access.

HWLOC_OBJ_SOCKET Socket, physical package, or chip. In the physical meaning, i.e. that you can add or remove physically.

HWLOC_OBJ_CACHE Data cache. Can be L1, L2, L3, ...

HWLOC_OBJ_CORE Core. A computation unit (may be shared by several logical processors).

HWLOC_OBJ_PU Processing Unit, or (Logical) Processor. An execution unit (may share a core with some other logical processors, e.g. in the case of an SMT core). Objects of this kind are always reported and can thus be used as fallback when others are not.

HWLOC_OBJ_GROUP Group objects. Objects which do not fit in the above but are detected by hwloc and are useful to take into account for affinity. For instance, some operating systems expose their arbitrary processors aggregation this way. And hwloc may insert such objects to group NUMA nodes according to their distances. These objects are ignored when they do not bring any structure.

HWLOC_OBJ_MISC Miscellaneous objects. Objects without particular meaning, that can e.g. be added by the application for its own use.

HWLOC_OBJ_BRIDGE Bridge. Any bridge that connects the host or an I/O bus, to another I/O bus. Bridge objects have neither CPU sets nor node sets. They are not added to the topology unless I/O discovery is enabled with [hwloc_topology_set_flags\(\)](#).

HWLOC_OBJ_PCI_DEVICE PCI device. These objects have neither CPU sets nor node sets. They are not added to the topology unless I/O discovery is enabled with [hwloc_topology_set_flags\(\)](#).

HWLOC_OBJ_OS_DEVICE Operating system device. These objects have neither CPU sets nor node sets. They are not added to the topology unless I/O discovery is enabled with [hwloc_topology_set_flags\(\)](#).

HWLOC_OBJ_TYPE_MAX Sentinel value

14.4.4 Function Documentation

14.4.4.1 HWLOC_DECLSPEC int hwloc_compare_types (hwloc_obj_type_t type1, hwloc_obj_type_t type2) const

Compare the depth of two object types.

Types shouldn't be compared as they are, since newer ones may be added in the future. This function returns less than, equal to, or greater than zero respectively if `type1` objects usually include `type2` objects, are the same as `type2` objects, or are included in `type2` objects. If the types can not be compared (because neither is usually contained in the other), `HWLOC_TYPE_UNORDERED` is returned. Object types containing CPUs can always be compared (usually, a system contains machines which contain nodes which contain sockets which contain caches, which contain cores, which contain processors).

Note

`HWLOC_OBJ_PU` will always be the deepest.

This does not mean that the actual topology will respect that order: e.g. as of today cores may also contain caches, and sockets may also contain nodes. This is thus just to be seen as a fallback comparison method.

14.5 Topology Objects

Data Structures

- struct [hwloc_obj_memory_s](#)
- struct [hwloc_obj](#)
- union [hwloc_obj_attr_u](#)
- struct [hwloc_distances_s](#)
- struct [hwloc_obj_info_s](#)

Typedefs

- typedef struct [hwloc_obj](#) * [hwloc_obj_t](#)

14.5.1 Detailed Description

14.5.2 Typedef Documentation

14.5.2.1 typedef struct [hwloc_obj](#)* [hwloc_obj_t](#)

Convenience typedef; a pointer to a struct [hwloc_obj](#).

14.6 Create and Destroy Topologies

Functions

- HWLOC_DECLSPEC int [hwloc_topology_init](#) ([hwloc_topology_t](#) *topologyp)
- HWLOC_DECLSPEC int [hwloc_topology_load](#) ([hwloc_topology_t](#) topology)
- HWLOC_DECLSPEC void [hwloc_topology_destroy](#) ([hwloc_topology_t](#) topology)
- HWLOC_DECLSPEC void [hwloc_topology_check](#) ([hwloc_topology_t](#) topology)

14.6.1 Detailed Description

14.6.2 Function Documentation

14.6.2.1 HWLOC_DECLSPEC void [hwloc_topology_check](#) ([hwloc_topology_t](#) topology)

Run internal checks on a topology structure.

The program aborts if an inconsistency is detected in the given topology.

Parameters

<i>topology</i>	is the topology to be checked
-----------------	-------------------------------

Note

This routine is only useful to developers.

The input topology should have been previously loaded with [hwloc_topology_load\(\)](#).

14.6.2.2 HWLOC_DECLSPEC void [hwloc_topology_destroy](#) ([hwloc_topology_t](#) topology)

Terminate and free a topology context.

Parameters

<i>topology</i>	is the topology to be freed
-----------------	-----------------------------

14.6.2.3 HWLOC_DECLSPEC int [hwloc_topology_init](#) ([hwloc_topology_t](#) * topologyp)

Allocate a topology context.

Parameters

out	<i>topologyp</i>	is assigned a pointer to the new allocated context.
-----	------------------	---

Returns

0 on success, -1 on error.

14.6.2.4 HWLOC_DECLSPEC int hwloc_topology_load (hwloc_topology_t topology)

Build the actual topology.

Build the actual topology once initialized with [hwloc_topology_init\(\)](#) and tuned with [Configure Topology Detection](#) routines. No other routine may be called earlier using this topology context.

Parameters

<i>topology</i>	is the topology to be loaded with objects.
-----------------	--

Returns

0 on success, -1 on error.

See Also

[Configure Topology Detection](#)

14.7 Configure Topology Detection

Data Structures

- struct [hwloc_topology_discovery_support](#)
- struct [hwloc_topology_cpupbind_support](#)
- struct [hwloc_topology_membind_support](#)
- struct [hwloc_topology_support](#)

Enumerations

- enum [hwloc_topology_flags_e](#) {
[HWLOC_TOPOLOGY_FLAG_WHOLE_SYSTEM](#), [HWLOC_TOPOLOGY_FLAG_IS_THISSYSTEM](#), [HWLOC_TOPOLOGY_FLAG_IO_DEVICES](#) = (1<<2), [HWLOC_TOPOLOGY_FLAG_IO_BRIDGES](#) = (1<<3),
[HWLOC_TOPOLOGY_FLAG_WHOLE_IO](#) = (1<<4) }

Functions

- HWLOC_DECLSPEC int [hwloc_topology_ignore_type](#) ([hwloc_topology_t](#) topology, [hwloc_obj_type_t](#) type)
- HWLOC_DECLSPEC int [hwloc_topology_ignore_type_keep_structure](#) ([hwloc_topology_t](#) topology, [hwloc_obj_type_t](#) type)
- HWLOC_DECLSPEC int [hwloc_topology_ignore_all_keep_structure](#) ([hwloc_topology_t](#) topology)
- HWLOC_DECLSPEC int [hwloc_topology_set_flags](#) ([hwloc_topology_t](#) topology, unsigned long flags)
- HWLOC_DECLSPEC int [hwloc_topology_set_fsroot](#) ([hwloc_topology_t](#) __hwloc_restrict topology, const char * __hwloc_restrict fsroot_path)
- HWLOC_DECLSPEC int [hwloc_topology_set_pid](#) ([hwloc_topology_t](#) __hwloc_restrict topology, [hwloc_pid_t](#) pid)
- HWLOC_DECLSPEC int [hwloc_topology_set_synthetic](#) ([hwloc_topology_t](#) __hwloc_restrict topology, const char * __hwloc_restrict description)
- HWLOC_DECLSPEC int [hwloc_topology_set_xml](#) ([hwloc_topology_t](#) __hwloc_restrict topology, const char * __hwloc_restrict xmlpath)
- HWLOC_DECLSPEC int [hwloc_topology_set_xmlbuffer](#) ([hwloc_topology_t](#) __hwloc_restrict topology, const char * __hwloc_restrict buffer, int size)
- HWLOC_DECLSPEC int [hwloc_topology_set_distance_matrix](#) ([hwloc_topology_t](#) __hwloc_restrict topology, [hwloc_obj_type_t](#) type, unsigned nbobjs, unsigned *os_index, float *distances)
- HWLOC_DECLSPEC struct [hwloc_topology_support](#) * [hwloc_topology_get_support](#) ([hwloc_topology_t](#) __hwloc_restrict topology)

14.7.1 Detailed Description

These functions can optionally be called between [hwloc_topology_init\(\)](#) and [hwloc_topology_load\(\)](#) to configure how the detection should be performed, e.g. to ignore some objects types, define a synthetic topology, etc.

If none of them is called, the default is to detect all the objects of the machine that the caller is allowed to access.

This default behavior may also be modified through environment variables if the application did not modify it already. Setting `HWLOC_XMLFILE` in the environment enforces the discovery from a XML file as if [hwloc_topology_set_xml\(\)](#) had been called. `HWLOC_FSROOT` switches to reading the topology from the specified Linux filesystem root as if [hwloc_topology_set_fsroot\(\)](#) had been called. Finally, `HWLOC_THISSYSTEM` enforces the return value of [hwloc_topology_is_thissystem\(\)](#).

14.7.2 Enumeration Type Documentation

14.7.2.1 enum hwloc_topology_flags_e

Flags to be set onto a topology context before load.

Flags should be given to [hwloc_topology_set_flags\(\)](#).

Enumerator

HWLOC_TOPOLOGY_FLAG_WHOLE_SYSTEM Detect the whole system, ignore reservations and offline settings. Gather all resources, even if some were disabled by the administrator. For instance, ignore Linux Cpusets and gather all processors and memory nodes, and ignore the fact that some resources may be offline.

HWLOC_TOPOLOGY_FLAG_IS_THISSYSTEM Assume that the selected backend provides the topology for the system on which we are running. This forces `hwloc_topology_is_thissystem` to return 1, i.e. makes `hwloc` assume that the selected backend provides the topology for the system on which we are running, even if it is not the OS-specific backend but the XML backend for instance. This means making the binding functions actually call the OS-specific system calls and really do binding, while the XML backend would otherwise provide empty hooks just returning success.

Setting the environment variable `HWLOC_THISSYSTEM` may also result in the same behavior.

This can be used for efficiency reasons to first detect the topology once, save it to an XML file, and quickly reload it later through the XML backend, but still having binding functions actually do bind.

HWLOC_TOPOLOGY_FLAG_IO_DEVICES

HWLOC_TOPOLOGY_FLAG_IO_BRIDGES

HWLOC_TOPOLOGY_FLAG_WHOLE_IO

14.7.3 Function Documentation

14.7.3.1 **HWLOC_DECLSPEC struct hwloc_topology_support*** `hwloc_topology_get_support (hwloc_topology_t _hwloc_restrict topology)` [read]

Retrieve the topology support.

14.7.3.2 **HWLOC_DECLSPEC int** `hwloc_topology_ignore_all_keep_structure (hwloc_topology_t topology)`

Ignore all objects that do not bring any structure.

Ignore all objects that do not bring any structure: Each ignored object should have a single children or be the only child of its parent. I/O objects may not be ignored, topology flags should be used to configure their discovery instead.

14.7.3.3 **HWLOC_DECLSPEC int** `hwloc_topology_ignore_type (hwloc_topology_t topology, hwloc_obj_type_t type)`

Ignore an object type.

Ignore all objects from the given type. The bottom-level type `HWLOC_OBJ_PU` may not be ignored. The top-level object of the hierarchy will never be ignored, even if this function succeeds. I/O objects may not be ignored, topology flags should be used to configure their discovery instead.

14.7.3.4 **HWLOC_DECLSPEC** int `hwloc_topology_ignore_type_keep_structure` (`hwloc_topology_t topology`,
`hwloc_obj_type_t type`)

Ignore an object type if it does not bring any structure.

Ignore all objects from the given type as long as they do not bring any structure: Each ignored object should have a single children or be the only child of its parent. The bottom-level type `HWLOC_OBJ_PU` may not be ignored. I/O objects may not be ignored, topology flags should be used to configure their discovery instead.

14.7.3.5 **HWLOC_DECLSPEC** int `hwloc_topology_set_distance_matrix` (`hwloc_topology_t topology`,
`hwloc_obj_type_t type`, unsigned `nobjs`, unsigned * `os_index`, float * `distances`)

Provide a distance matrix.

Provide the matrix of distances between a set of objects of the given type. The set may or may not contain all the existing objects of this type. The objects are specified by their OS/physical index in the `os_index` array. The `distances` matrix follows the same order. The distance from object `i` to object `j` in the `i*nobjs+j`.

A single latency matrix may be defined for each type. If another distance matrix already exists for the given type, either because the user specified it or because the OS offers it, it will be replaced by the given one. If `nobjs` is 0, `os_index` is `NULL` and `distances` is `NULL`, the existing distance matrix for the given type is removed.

14.7.3.6 **HWLOC_DECLSPEC** int `hwloc_topology_set_flags` (`hwloc_topology_t topology`, unsigned long `flags`)

Set OR'ed flags to non-yet-loaded topology.

Set a OR'ed set of `hwloc_topology_flags_e` onto a topology that was not yet loaded.

14.7.3.7 **HWLOC_DECLSPEC** int `hwloc_topology_set_fsroot` (`hwloc_topology_t topology`, const char
*`hwloc_restrict_fsroot_path`)

Change the file-system root path when building the topology from `sysfs/procfs`.

On Linux system, use `sysfs` and `procfs` files as if they were mounted on the given `fsroot_path` instead of the main file-system root. Setting the environment variable `HWLOC_FSROOT` may also result in this behavior. Not using the main file-system root causes `hwloc_topology_is_thissystem()` to return 0.

Note that this function does not actually load topology information; it just tells `hwloc` where to load it from. You'll still need to invoke `hwloc_topology_load()` to actually load the topology information.

Note

For convenience, this backend provides empty binding hooks which just return success. To have `hwloc` still actually call OS-specific hooks, the `HWLOC_TOPOLOGY_FLAG_IS_THISSYSTEM` has to be set to assert that the loaded file is really the underlying system.

14.7.3.8 **HWLOC_DECLSPEC** int `hwloc_topology_set_pid` (`hwloc_topology_t topology`, `hwloc_pid_t pid`)

Change which pid the topology is viewed from.

On some systems, processes may have different views of the machine, for instance the set of allowed CPUs. By default, `hwloc` exposes the view from the current process. Calling `hwloc_topology_set_pid()` permits to make it expose the topology of the machine from the point of view of another process.

Note

`hwloc_pid_t` is `pid_t` on Unix platforms, and `HANDLE` on native Windows platforms.
-1 is returned and `errno` is set to `ENOSYS` on platforms that do not support this feature.

14.7.3.9 `HWLOC_DECLSPEC int hwloc_topology_set_synthetic (hwloc_topology_t __hwloc_restrict topology, const char *__hwloc_restrict description)`

Enable synthetic topology.

Gather topology information from the given `description`, a space-separated string of numbers describing the arity of each level. Each number may be prefixed with a type and a colon to enforce the type of a level. If only some level types are enforced, `hwloc` will try to choose the other types according to usual topologies, but it may fail and you may have to specify more level types manually.

If `description` was properly parsed and describes a valid topology configuration, this function returns 0. Otherwise -1 is returned and `errno` is set to `EINVAL`.

Note that this function does not actually load topology information; it just tells `hwloc` where to load it from. You'll still need to invoke `hwloc_topology_load()` to actually load the topology information.

Note

For convenience, this backend provides empty binding hooks which just return success.

14.7.3.10 `HWLOC_DECLSPEC int hwloc_topology_set_xml (hwloc_topology_t __hwloc_restrict topology, const char *__hwloc_restrict xmlpath)`

Enable XML-file based topology.

Gather topology information from the XML file given at `xmlpath`. Setting the environment variable `HWLOC_XMLFILE` may also result in this behavior. This file may have been generated earlier with `lstopo file.xml`.

Note that this function does not actually load topology information; it just tells `hwloc` where to load it from. You'll still need to invoke `hwloc_topology_load()` to actually load the topology information.

Note

For convenience, this backend provides empty binding hooks which just return success. To have `hwloc` still actually call OS-specific hooks, the `HWLOC_TOPOLOGY_FLAG_IS_THISSYSTEM` has to be set to assert that the loaded file is really the underlying system.

14.7.3.11 `HWLOC_DECLSPEC int hwloc_topology_set_xmlbuffer (hwloc_topology_t __hwloc_restrict topology, const char *__hwloc_restrict buffer, int size)`

Enable XML based topology using a memory buffer (instead of a file, as with `hwloc_topology_set_xml()`).

Gather topology information from the XML memory buffer given at `buffer` and of length `size`. This buffer may have been filled earlier with `hwloc_topology_export_xmlbuffer()`.

Note that this function does not actually load topology information; it just tells `hwloc` where to load it from. You'll still need to invoke `hwloc_topology_load()` to actually load the topology information.

14.8 Tinker With Topologies.

Enumerations

- enum `hwloc_restrict_flags_e` { `HWLOC_RESTRICT_FLAG_ADAPT_DISTANCES`, `HWLOC_RESTRICT_FLAG_ADAPT_MISC`, `HWLOC_RESTRICT_FLAG_ADAPT_IO` }

Functions

- HWLOC_DECLSPEC int `hwloc_topology_export_xml` (`hwloc_topology_t` topology, const char *xmlpath)
- HWLOC_DECLSPEC int `hwloc_topology_export_xmlbuffer` (`hwloc_topology_t` topology, char **xmlbuffer, int *buflen)
- HWLOC_DECLSPEC void `hwloc_free_xmlbuffer` (`hwloc_topology_t` topology, char *xmlbuffer)
- HWLOC_DECLSPEC `hwloc_obj_t` `hwloc_topology_insert_misc_object_by_cpuset` (`hwloc_topology_t` topology, `hwloc_const_cpuset_t` cpuset, const char *name)
- HWLOC_DECLSPEC `hwloc_obj_t` `hwloc_topology_insert_misc_object_by_parent` (`hwloc_topology_t` topology, `hwloc_obj_t` parent, const char *name)
- HWLOC_DECLSPEC int `hwloc_topology_restrict` (`hwloc_topology_t` topology, `hwloc_restrict_flags_e` flags)

14.8.1 Detailed Description

14.8.2 Enumeration Type Documentation

14.8.2.1 enum `hwloc_restrict_flags_e`

Flags to be given to `hwloc_topology_restrict()`.

Enumerator

`HWLOC_RESTRICT_FLAG_ADAPT_DISTANCES` Adapt distance matrices according to objects being removed during restriction. If this flag is not set, distance matrices are removed.

`HWLOC_RESTRICT_FLAG_ADAPT_MISC` Move Misc objects to ancestors if their parents are removed during restriction. If this flag is not set, Misc objects are removed when their parents are removed.

`HWLOC_RESTRICT_FLAG_ADAPT_IO` Move I/O objects to ancestors if their parents are removed during restriction. If this flag is not set, I/O devices and bridges are removed when their parents are removed.

14.8.3 Function Documentation

14.8.3.1 HWLOC_DECLSPEC void `hwloc_free_xmlbuffer` (`hwloc_topology_t` topology, char * xmlbuffer)

Free a buffer allocated by `hwloc_topology_export_xmlbuffer()`

14.8.3.2 HWLOC_DECLSPEC int `hwloc_topology_export_xml` (`hwloc_topology_t` topology, const char * xmlpath)

Export the topology into an XML file.

This file may be loaded later through `hwloc_topology_set_xml()`.

Returns

-1 if a failure occurred.

14.8.3.3 `HWLOC_DECLSPEC int hwloc_topology_export_xmlbuffer (hwloc_topology_t topology, char ** xmlbuffer, int * buflen)`

Export the topology into a newly-allocated XML memory buffer.

`xmlbuffer` is allocated by the callee and should be freed with [hwloc_free_xmlbuffer\(\)](#) later in the caller.

This memory buffer may be loaded later through [hwloc_topology_set_xmlbuffer\(\)](#).

Returns

-1 if a failure occurred.

14.8.3.4 `HWLOC_DECLSPEC hwloc_obj_t hwloc_topology_insert_misc_object_by_cpuset (hwloc_topology_t topology, hwloc_const_cpuset_t cpuset, const char * name)`

Add a MISC object to the topology.

A new MISC object will be created and inserted into the topology at the position given by bitmap `cpuset`. This offers a way to add new intermediate levels to the topology hierarchy.

`cpuset` and `name` will be copied to setup the new object attributes.

Returns

the newly-created object.

NULL if the insertion conflicts with the existing topology tree.

14.8.3.5 `HWLOC_DECLSPEC hwloc_obj_t hwloc_topology_insert_misc_object_by_parent (hwloc_topology_t topology, hwloc_obj_t parent, const char * name)`

Add a MISC object as a leaf of the topology.

A new MISC object will be created and inserted into the topology at the position given by `parent`. It is appended to the list of existing children, without ever adding any intermediate hierarchy level. This is useful for annotating the topology without actually changing the hierarchy.

`name` will be copied to the setup the new object attributes. However, the new leaf object will not have any `cpuset`.

Returns

the newly-created object

14.8.3.6 `HWLOC_DECLSPEC int hwloc_topology_restrict (hwloc_topology_t topology, hwloc_const_cpuset_t cpuset, unsigned long flags)`

Restrict the topology to the given CPU set.

Topology `topology` is modified so as to remove all objects that are not included (or partially included) in the CPU set `cpuset`. All objects CPU and node sets are restricted accordingly.

`flags` is a OR'ed set of [hwloc_restrict_flags_e](#).

Note

This call may not be reverted by restricting back to a larger cpuset. Once dropped during restriction, objects may not be brought back, except by reloading the entire topology with [hwloc_topology_load\(\)](#).

14.9 Get Some Topology Information

Enumerations

- enum `hwloc_get_type_depth_e` {
`HWLOC_TYPE_DEPTH_UNKNOWN`, `HWLOC_TYPE_DEPTH_MULTIPLE`, `HWLOC_TYPE_DEPTH_BRIDGE`,
`HWLOC_TYPE_DEPTH_PCI_DEVICE`,
`HWLOC_TYPE_DEPTH_OS_DEVICE` }

Functions

- `HWLOC_DECLSPEC` unsigned `hwloc_topology_get_depth` (`hwloc_topology_t` topology) `__hwloc_attribute_pure`
- `HWLOC_DECLSPEC` int `hwloc_get_type_depth` (`hwloc_topology_t` topology, `hwloc_obj_type_t` type)
- `HWLOC_DECLSPEC` `hwloc_obj_type_t` `hwloc_get_depth_type` (`hwloc_topology_t` topology, unsigned depth) `__hwloc_attribute_pure`
- `HWLOC_DECLSPEC` unsigned `hwloc_get_nobjs_by_depth` (`hwloc_topology_t` topology, unsigned depth) `__hwloc_attribute_pure`
- static `__hwloc_inline` int `hwloc_get_nobjs_by_type` (`hwloc_topology_t` topology, `hwloc_obj_type_t` type) `__hwloc_attribute_pure`
- `HWLOC_DECLSPEC` int `hwloc_topology_is_thissystem` (`hwloc_topology_t` topology) `__hwloc_attribute_pure`

14.9.1 Detailed Description

Be sure to see the figure in [Terms and Definitions](#) that shows a complete topology tree, including depths, child/sibling/-cousin relationships, and an example of an asymmetric topology where one socket has fewer caches than its peers.

14.9.2 Enumeration Type Documentation

14.9.2.1 enum `hwloc_get_type_depth_e`

Enumerator

- `HWLOC_TYPE_DEPTH_UNKNOWN`** No object of given type exists in the topology.
- `HWLOC_TYPE_DEPTH_MULTIPLE`** Objects of given type exist at different depth in the topology.
- `HWLOC_TYPE_DEPTH_BRIDGE`** Virtual depth for bridge object level.
- `HWLOC_TYPE_DEPTH_PCI_DEVICE`** Virtual depth for PCI device object level.
- `HWLOC_TYPE_DEPTH_OS_DEVICE`** Virtual depth for software device object level.

14.9.3 Function Documentation

14.9.3.1 `HWLOC_DECLSPEC` `hwloc_obj_type_t` `hwloc_get_depth_type` (`hwloc_topology_t` topology, unsigned depth)

Returns the type of objects at depth `depth`.

Returns

- 1 if depth `depth` does not exist.

14.9.3.2 HWLOC_DECLSPEC unsigned hwloc_get_nbobjs_by_depth (hwloc_topology_t topology, unsigned depth)

Returns the width of level at depth `depth`.

14.9.3.3 static __hwloc_inline int hwloc_get_nbobjs_by_type (hwloc_topology_t topology, hwloc_obj_type_t type)
[static]

Returns the width of level `type`.

If no object for that type exists, 0 is returned. If there are several levels with objects of that type, -1 is returned.

14.9.3.4 HWLOC_DECLSPEC int hwloc_get_type_depth (hwloc_topology_t topology, hwloc_obj_type_t type)

Returns the depth of objects of type `type`.

If no object of this type is present on the underlying architecture, or if the OS doesn't provide this kind of information, the function returns `HWLOC_TYPE_DEPTH_UNKNOWN`.

If `type` is absent but a similar type is acceptable, see also [hwloc_get_type_or_below_depth\(\)](#) and [hwloc_get_type_or_above_depth\(\)](#).

If some objects of the given type exist in different levels, for instance L1 and L2 caches, the function returns `HWLOC_TYPE_DEPTH_MULTIPLE`.

If an I/O object type is given, the function returns a virtual value because I/O objects are stored in special levels that are not CPU-related. This virtual depth may be passed to other hwloc functions such as [hwloc_get_obj_by_depth\(\)](#) but it should not be considered as an actual depth by the application. In particular, it should not be compared with any other object depth or with the entire topology depth.

14.9.3.5 HWLOC_DECLSPEC unsigned hwloc_topology_get_depth (hwloc_topology_t __hwloc_restrict topology)

Get the depth of the hierarchical tree of objects.

This is the depth of `HWLOC_OBJ_PU` objects plus one.

14.9.3.6 HWLOC_DECLSPEC int hwloc_topology_is_thissystem (hwloc_topology_t __hwloc_restrict topology)

Does the topology context come from this system?

Returns

1 if this topology context was built using the system running this program.

0 instead (for instance if using another file-system root, a XML topology file, or a synthetic topology).

14.10 Retrieve Objects

Functions

- HWLOC_DECLSPEC [hwloc_obj_t hwloc_get_obj_by_depth](#) ([hwloc_topology_t](#) topology, unsigned depth, unsigned idx) [__hwloc_attribute_pure](#)
- static [__hwloc_inline hwloc_obj_t hwloc_get_obj_by_type](#) ([hwloc_topology_t](#) topology, [hwloc_obj_type_t](#) type, unsigned idx) [__hwloc_attribute_pure](#)

14.10.1 Detailed Description

Be sure to see the figure in [Terms and Definitions](#) that shows a complete topology tree, including depths, child/sibling/-cousin relationships, and an example of an asymmetric topology where one socket has fewer caches than its peers.

14.10.2 Function Documentation

14.10.2.1 HWLOC_DECLSPEC [hwloc_obj_t hwloc_get_obj_by_depth](#) ([hwloc_topology_t](#) *topology*, unsigned *depth*, unsigned *idx*)

Returns the topology object at logical index *idx* from depth *depth*.

14.10.2.2 static [__hwloc_inline hwloc_obj_t hwloc_get_obj_by_type](#) ([hwloc_topology_t](#) *topology*, [hwloc_obj_type_t](#) *type*, unsigned *idx*) [*static*]

Returns the topology object at logical index *idx* with type *type*.

If no object for that type exists, NULL is returned. If there are several levels with objects of that type, NULL is returned and the caller may fallback to [hwloc_get_obj_by_depth\(\)](#).

14.11 Object/String Conversion

Functions

- HWLOC_DECLSPEC const char * [hwloc_obj_type_string](#) ([hwloc_obj_type_t](#) type) `__hwloc_attribute_const`
- HWLOC_DECLSPEC [hwloc_obj_type_t hwloc_obj_type_of_string](#) (const char *string) `__hwloc_attribute_pure`
- HWLOC_DECLSPEC int [hwloc_obj_type_snprintf](#) (char *__hwloc_restrict string, size_t size, [hwloc_obj_t](#) obj, int verbose)
- HWLOC_DECLSPEC int [hwloc_obj_attr_snprintf](#) (char *__hwloc_restrict string, size_t size, [hwloc_obj_t](#) obj, const char *__hwloc_restrict separator, int verbose)
- HWLOC_DECLSPEC int [hwloc_obj_snprintf](#) (char *__hwloc_restrict string, size_t size, [hwloc_topology_t](#) topology, [hwloc_obj_t](#) obj, const char *__hwloc_restrict indexprefix, int verbose)
- HWLOC_DECLSPEC int [hwloc_obj_cpuset_snprintf](#) (char *__hwloc_restrict str, size_t size, size_t nobj, const [hwloc_obj_t](#) *__hwloc_restrict objs)
- static `__hwloc_inline` const char * [hwloc_obj_get_info_by_name](#) ([hwloc_obj_t](#) obj, const char *name) `__hwloc_attribute_pure`
- HWLOC_DECLSPEC void [hwloc_obj_add_info](#) ([hwloc_obj_t](#) obj, const char *name, const char *value)

14.11.1 Detailed Description

14.11.2 Function Documentation

14.11.2.1 HWLOC_DECLSPEC void [hwloc_obj_add_info](#) ([hwloc_obj_t](#) obj, const char * name, const char * value)

Add the given info name and value pair to the given object.

The info is appended to the existing info array even if another key with the same name already exists.

The input strings are copied before being added in the object infos.

14.11.2.2 HWLOC_DECLSPEC int [hwloc_obj_attr_snprintf](#) (char *__hwloc_restrict string, size_t size, [hwloc_obj_t](#) obj, const char *__hwloc_restrict separator, int verbose)

Stringify the attributes of a given topology object into a human-readable form.

Attribute values are separated by `separator`.

Only the major attributes are printed in non-verbose mode.

If `size` is 0, `string` may safely be NULL.

Returns

the number of character that were actually written if not truncating, or that would have been written (not including the ending `\0`).

14.11.2.3 HWLOC_DECLSPEC int [hwloc_obj_cpuset_snprintf](#) (char *__hwloc_restrict str, size_t size, size_t nobj, const [hwloc_obj_t](#) *__hwloc_restrict objs)

Stringify the cpuset containing a set of objects.

If `size` is 0, `string` may safely be NULL.

Returns

the number of character that were actually written if not truncating, or that would have been written (not including the ending `\0`).

14.11.2.4 `static __hwloc_inline const char * hwloc_obj_get_info_by_name (hwloc_obj_t obj, const char * name)` [static]

Search the given key name in object infos and return the corresponding value.

If multiple keys match the given name, only the first one is returned.

Returns

NULL if no such key exists.

14.11.2.5 `HWLOC_DECLSPEC int hwloc_obj_snprintf (char *__hwloc_restrict string, size_t size, hwloc_topology_t topology, hwloc_obj_t obj, const char *__hwloc_restrict indexprefix, int verbose)`

Stringify a given topology object into a human-readable form.

Note

This function is deprecated in favor of [hwloc_obj_type_snprintf\(\)](#) and [hwloc_obj_attr_snprintf\(\)](#) since it is not very flexible and only prints physical/OS indexes.

Fill string `string` up to `size` characters with the description of topology object `obj` in topology `topology`.

If `verbose` is set, a longer description is used. Otherwise a short description is used.

`indexprefix` is used to prefix the `os_index` attribute number of the object in the description. If NULL, the `#` character is used.

If `size` is 0, `string` may safely be NULL.

Returns

the number of character that were actually written if not truncating, or that would have been written (not including the ending `\0`).

14.11.2.6 `HWLOC_DECLSPEC hwloc_obj_type_t hwloc_obj_type_of_string (const char * string)`

Return an object type from the string.

Returns

-1 if unrecognized.

14.11.2.7 `HWLOC_DECLSPEC int hwloc_obj_type_snprintf (char *__hwloc_restrict string, size_t size, hwloc_obj_t obj, int verbose)`

Stringify the type of a given topology object into a human-readable form.

It differs from [hwloc_obj_type_string\(\)](#) because it prints type attributes such as cache depth.

If `size` is 0, `string` may safely be NULL.

Returns

the number of character that were actually written if not truncating, or that would have been written (not including the ending \0).

14.11.2.8 `HWLOC_DECLSPEC const char* hwloc_obj_type_string (hwloc_obj_type_t type) const`

Return a stringified topology object type.

14.12 CPU binding

Enumerations

- enum `hwloc_cpubind_flags_t` { `HWLOC_CPUBIND_PROCESS`, `HWLOC_CPUBIND_THREAD`, `HWLOC_CPUBIND_STRICT`, `HWLOC_CPUBIND_NOMEMBIND` }

Functions

- `HWLOC_DECLSPEC int hwloc_set_cpubind(hwloc_topology_t topology, hwloc_const_cpuset_t set, int flags)`
- `HWLOC_DECLSPEC int hwloc_get_cpubind(hwloc_topology_t topology, hwloc_cpuset_t set, int flags)`
- `HWLOC_DECLSPEC int hwloc_set_proc_cpubind(hwloc_topology_t topology, hwloc_pid_t pid, hwloc_const_cpuset_t set, int flags)`
- `HWLOC_DECLSPEC int hwloc_get_proc_cpubind(hwloc_topology_t topology, hwloc_pid_t pid, hwloc_cpuset_t set, int flags)`
- `HWLOC_DECLSPEC int hwloc_set_thread_cpubind(hwloc_topology_t topology, hwloc_thread_t thread, hwloc_const_cpuset_t set, int flags)`
- `HWLOC_DECLSPEC int hwloc_get_thread_cpubind(hwloc_topology_t topology, hwloc_thread_t thread, hwloc_cpuset_t set, int flags)`
- `HWLOC_DECLSPEC int hwloc_get_last_cpu_location(hwloc_topology_t topology, hwloc_cpuset_t set, int flags)`
- `HWLOC_DECLSPEC int hwloc_get_proc_last_cpu_location(hwloc_topology_t topology, hwloc_pid_t pid, hwloc_cpuset_t set, int flags)`

14.12.1 Detailed Description

It is often useful to call `hwloc_bitmap_singlify()` first so that a single CPU remains in the set. This way, the process will not even migrate between different CPUs. Some operating systems also only support that kind of binding.

Note

Some operating systems do not provide all hwloc-supported mechanisms to bind processes, threads, etc. and the corresponding binding functions may fail. -1 is returned and `errno` is set to `ENOSYS` when it is not possible to bind the requested kind of object processes/threads. `errno` is set to `EXDEV` when the requested cpuset can not be enforced (e.g. some systems only allow one CPU, and some other systems only allow one NUMA node).

The most portable version that should be preferred over the others, whenever possible, is

```
hwloc_set_cpubind(topology, set, 0),
```

as it just binds the current program, assuming it is single-threaded, or

```
hwloc_set_cpubind(topology, set, HWLOC_CPUBIND_THREAD),
```

which binds the current thread of the current program (which may be multithreaded).

Note

To unbind, just call the binding function with either a full cpuset or a cpuset equal to the system cpuset.

On some operating systems, CPU binding may have effects on memory binding, see [HWLOC_CPUBIND_NOMEMBIND](#)

Running `lstopo -top` can be a very convenient tool to check how binding actually happened.

14.12.2 Enumeration Type Documentation

14.12.2.1 enum `hwloc_cpubind_flags_t`

Process/Thread binding flags.

These bit flags can be used to refine the binding policy.

The default (0) is to bind the current process, assumed to be single-threaded, in a non-strict way. This is the most portable way to bind as all operating systems usually provide it.

Note

Not all systems support all kinds of binding. See the "Detailed Description" section of [CPU binding](#) for a description of errors that can occur.

Enumerator

`HWLOC_CPUBIND_PROCESS` Bind all threads of the current (possibly) multithreaded process.

`HWLOC_CPUBIND_THREAD` Bind current thread of current process.

`HWLOC_CPUBIND_STRICT` Request for strict binding from the OS. By default, when the designated CPUs are all busy while other CPUs are idle, operating systems may execute the thread/process on those other CPUs instead of the designated CPUs, to let them progress anyway. Strict binding means that the thread/process will `_never_` execute on other cpus than the designated CPUs, even when those are busy with other tasks and other CPUs are idle.

Note

Depending on the operating system, strict binding may not be possible (e.g., the OS does not implement it) or not allowed (e.g., for an administrative reasons), and the function will fail in that case.

When retrieving the binding of a process, this flag checks whether all its threads actually have the same binding. If the flag is not given, the binding of each thread will be accumulated.

Note

This flag is meaningless when retrieving the binding of a thread.

`HWLOC_CPUBIND_NOMEMBIND` Avoid any effect on memory binding. On some operating systems, some CPU binding function would also bind the memory on the corresponding NUMA node. It is often not a problem for the application, but if it is, setting this flag will make hwloc avoid using OS functions that would also bind memory. This will however reduce the support of CPU bindings, i.e. potentially return -1 with `errno` set to `ENOSYS` in some cases.

This flag is only meaningful when used with functions that set the CPU binding. It is ignored when used with functions that get CPU binding information.

14.12.3 Function Documentation

14.12.3.1 `HWLOC_DECLSPEC int hwloc_get_cpubind (hwloc_topology_t topology, hwloc_cpuset_t set, int flags)`

Get current process or thread binding.

Writes into `set` the physical cpuset which the process or thread (according to `flags`) was last bound to.

14.12.3.2 `HWLOC_DECLSPEC int hwloc_get_last_cpu_location (hwloc_topology_t topology, hwloc_cpuset_t set, int flags)`

Get the last physical CPU where the current process or thread ran.

The operating system may move some tasks from one processor to another at any time according to their binding, so this function may return something that is already outdated.

14.12.3.3 **HWLOC_DECLSPEC** int `hwloc_get_proc_cpubind` (`hwloc_topology_t topology`, `hwloc_pid_t pid`, `hwloc_cpuset_t set`, int `flags`)

Get the current physical binding of process `pid`.

Note

`hwloc_pid_t` is `pid_t` on Unix platforms, and `HANDLE` on native Windows platforms.

`HWLOC_CPUBIND_THREAD` can not be used in `flags`.

As a special case on Linux, if a `tid` (thread ID) is supplied instead of a `pid` (process ID), the binding for that specific thread is returned.

14.12.3.4 **HWLOC_DECLSPEC** int `hwloc_get_proc_last_cpu_location` (`hwloc_topology_t topology`, `hwloc_pid_t pid`, `hwloc_cpuset_t set`, int `flags`)

Get the last physical CPU where a process ran.

The operating system may move some tasks from one processor to another at any time according to their binding, so this function may return something that is already outdated.

Note

`hwloc_pid_t` is `pid_t` on Unix platforms, and `HANDLE` on native Windows platforms.

`HWLOC_CPUBIND_THREAD` can not be used in `flags`.

As a special case on Linux, if a `tid` (thread ID) is supplied instead of a `pid` (process ID), the binding for that specific thread is returned.

14.12.3.5 **HWLOC_DECLSPEC** int `hwloc_get_thread_cpubind` (`hwloc_topology_t topology`, `hwloc_thread_t thread`, `hwloc_cpuset_t set`, int `flags`)

Get the current physical binding of thread `tid`.

Note

`hwloc_thread_t` is `pthread_t` on Unix platforms, and `HANDLE` on native Windows platforms.

`HWLOC_CPUBIND_PROCESS` can not be used in `flags`.

14.12.3.6 **HWLOC_DECLSPEC** int `hwloc_set_cpubind` (`hwloc_topology_t topology`, `hwloc_const_cpuset_t set`, int `flags`)

Bind current process or thread on cpus given in physical bitmap `set`.

Returns

-1 with `errno` set to `ENOSYS` if the action is not supported

-1 with `errno` set to `EXDEV` if the binding cannot be enforced

14.12.3.7 **HWLOC_DECLSPEC** int `hwloc_set_proc_cpubind` (`hwloc_topology_t topology`, `hwloc_pid_t pid`, `hwloc_const_cpuset_t set`, int `flags`)

Bind a process `pid` on cpus given in physical bitmap `set`.

Note

`hwloc_pid_t` is `pid_t` on Unix platforms, and `HANDLE` on native Windows platforms.
`HWLOC_CPUBIND_THREAD` can not be used in `flags`.

14.12.3.8 `HWLOC_DECLSPEC int hwloc_set_thread_cpupbind (hwloc_topology_t topology, hwloc_thread_t thread, hwloc_const_cpuset_t set, int flags)`

Bind a thread `thread` on cpus given in physical bitmap `set`.

Note

`hwloc_thread_t` is `pthread_t` on Unix platforms, and `HANDLE` on native Windows platforms.
`HWLOC_CPUBIND_PROCESS` can not be used in `flags`.

14.13 Memory binding

Enumerations

- enum `hwloc_membind_policy_t` {
`HWLOC_MEMBIND_DEFAULT`, `HWLOC_MEMBIND_FIRSTTOUCH`, `HWLOC_MEMBIND_BIND`, `HWLOC_MEMBIND_INTERLEAVE`,
`HWLOC_MEMBIND_REPLICATE`, `HWLOC_MEMBIND_NEXTTOUCH`, `HWLOC_MEMBIND_MIXED` }
- enum `hwloc_membind_flags_t` {
`HWLOC_MEMBIND_PROCESS`, `HWLOC_MEMBIND_THREAD`, `HWLOC_MEMBIND_STRICT`, `HWLOC_MEMBIND_MIGRATE`,
`HWLOC_MEMBIND_NOCPUBIND` }

Functions

- `HWLOC_DECLSPEC int hwloc_set_membind_nodese`t (`hwloc_topology_t` topology, `hwloc_const_nodese`t_t nodeset, `hwloc_membind_policy_t` policy, int flags)
- `HWLOC_DECLSPEC int hwloc_set_membind` (`hwloc_topology_t` topology, `hwloc_const_cpuse`t_t cpuset, `hwloc_membind_policy_t` policy, int flags)
- `HWLOC_DECLSPEC int hwloc_get_membind_nodese`t (`hwloc_topology_t` topology, `hwloc_nodese`t_t nodeset, `hwloc_membind_policy_t` *policy, int flags)
- `HWLOC_DECLSPEC int hwloc_get_membind` (`hwloc_topology_t` topology, `hwloc_cpuse`t_t cpuset, `hwloc_membind_policy_t` *policy, int flags)
- `HWLOC_DECLSPEC int hwloc_set_proc_membind_nodese`t (`hwloc_topology_t` topology, `hwloc_pid_t` pid, `hwloc_const_nodese`t_t nodeset, `hwloc_membind_policy_t` policy, int flags)
- `HWLOC_DECLSPEC int hwloc_set_proc_membind` (`hwloc_topology_t` topology, `hwloc_pid_t` pid, `hwloc_const_cpuse`t_t cpuset, `hwloc_membind_policy_t` policy, int flags)
- `HWLOC_DECLSPEC int hwloc_get_proc_membind_nodese`t (`hwloc_topology_t` topology, `hwloc_pid_t` pid, `hwloc_nodese`t_t nodeset, `hwloc_membind_policy_t` *policy, int flags)
- `HWLOC_DECLSPEC int hwloc_get_proc_membind` (`hwloc_topology_t` topology, `hwloc_pid_t` pid, `hwloc_cpuse`t_t cpuset, `hwloc_membind_policy_t` *policy, int flags)
- `HWLOC_DECLSPEC int hwloc_set_area_membind_nodese`t (`hwloc_topology_t` topology, const void *addr, size_t len, `hwloc_const_nodese`t_t nodeset, `hwloc_membind_policy_t` policy, int flags)
- `HWLOC_DECLSPEC int hwloc_set_area_membind` (`hwloc_topology_t` topology, const void *addr, size_t len, `hwloc_const_cpuse`t_t cpuset, `hwloc_membind_policy_t` policy, int flags)
- `HWLOC_DECLSPEC int hwloc_get_area_membind_nodese`t (`hwloc_topology_t` topology, const void *addr, size_t len, `hwloc_nodese`t_t nodeset, `hwloc_membind_policy_t` *policy, int flags)
- `HWLOC_DECLSPEC int hwloc_get_area_membind` (`hwloc_topology_t` topology, const void *addr, size_t len, `hwloc_cpuse`t_t cpuset, `hwloc_membind_policy_t` *policy, int flags)
- `HWLOC_DECLSPEC void * hwloc_alloc` (`hwloc_topology_t` topology, size_t len)
- `HWLOC_DECLSPEC void * hwloc_alloc_membind_nodese`t (`hwloc_topology_t` topology, size_t len, `hwloc_const_nodese`t_t nodeset, `hwloc_membind_policy_t` policy, int flags) `__hwloc_attribute_malloc`
- `HWLOC_DECLSPEC void * hwloc_alloc_membind` (`hwloc_topology_t` topology, size_t len, `hwloc_const_cpuse`t_t cpuset, `hwloc_membind_policy_t` policy, int flags) `__hwloc_attribute_malloc`
- `HWLOC_DECLSPEC int hwloc_free` (`hwloc_topology_t` topology, void *addr, size_t len)

14.13.1 Detailed Description

Note

Not all operating systems support all ways to bind existing allocated memory (e.g., migration), future memory allocation, explicit memory allocation, etc. Using a binding flag or policy that is not supported by the underlying OS will cause hwloc's binding functions to fail and return -1. `errno` will be set to `ENOSYS` when the system does support the specified action or policy (e.g., some systems only allow binding memory on a per-thread basis, whereas other systems only allow binding memory for all threads in a process). `errno` will be set to `EXDEV` when the requested `cpuset` can not be enforced (e.g., some systems only allow binding memory to a single NUMA node).

The most portable form that should be preferred over the others whenever possible is as follows:

```
hwloc_alloc_membind_policy(topology, size, set,
                          HWLOC_MEMBIND_DEFAULT, 0);
```

This will allocate some memory hopefully bound to the specified set. To do so, hwloc will possibly have to change the current memory binding policy in order to actually get the memory bound, if the OS does not provide any other way to simply allocate bound memory without changing the policy for all allocations. That is the difference with `hwloc_alloc_membind()`, which will never change the current memory binding policy. Note that since `HWLOC_MEMBIND_STRICT` was not specified, failures to bind will not be reported – generally, only memory allocation failures will be reported (e.g., even a plain `malloc()` would have failed with `ENOMEM`).

Each hwloc memory binding function is available in two forms: one that takes a CPU set argument and another that takes a NUMA memory node set argument (see [Object sets \(hwloc_cpuset_t and hwloc_nodeset_t\)](#) and [The bitmap API](#) for a discussion of CPU sets and NUMA memory node sets). The names of the latter form end with `_nodeset`. It is also possible to convert between CPU set and node set using `hwloc_cpuset_to_nodeset()` or `hwloc_cpuset_from_nodeset()`.

Note

On some operating systems, memory binding affects the CPU binding; see [HWLOC_MEMBIND_NOCPUBIND](#)

14.13.2 Enumeration Type Documentation**14.13.2.1 enum hwloc_membind_flags_t**

Memory binding flags.

These flags can be used to refine the binding policy. All flags can be logically OR'ed together with the exception of `HWLOC_MEMBIND_PROCESS` and `HWLOC_MEMBIND_THREAD`; these two flags are mutually exclusive.

Note

Not all systems support all kinds of binding. See the "Detailed Description" section of [Memory binding](#) for a description of errors that can occur.

Enumerator

HWLOC_MEMBIND_PROCESS Set policy for all threads of the specified (possibly multithreaded) process. This flag is mutually exclusive with `HWLOC_MEMBIND_THREAD`.

HWLOC_MEMBIND_THREAD Set policy for a specific thread of the current process. This flag is mutually exclusive with `HWLOC_MEMBIND_PROCESS`.

HWLOC_MEMBIND_STRICT Request strict binding from the OS. The function will fail if the binding can not be guaranteed / completely enforced.

This flag has slightly different meanings depending on which function it is used with.

HWLOC_MEMBIND_MIGRATE Migrate existing allocated memory. If the memory cannot be migrated and the `HWLOC_MEMBIND_STRICT` flag is passed, an error will be returned.

HWLOC_MEMBIND_NOCPUBIND Avoid any effect on CPU binding. On some operating systems, some underlying memory binding functions also bind the application to the corresponding CPU(s). Using this flag will cause hwloc to avoid using OS functions that could potentially affect CPU bindings. Note, however, that using NOCPUBIND may reduce hwloc's overall memory binding support. Specifically: some of hwloc's memory binding functions may fail with `errno` set to `ENOSYS` when used with NOCPUBIND.

14.13.2.2 enum hwloc_membind_policy_t

Memory binding policy.

These constants can be used to choose the binding policy. Only one policy can be used at a time (i.e., the values cannot be OR'ed together).

Note

Not all systems support all kinds of binding. See the "Detailed Description" section of [Memory binding](#) for a description of errors that can occur.

Enumerator

HWLOC_MEMBIND_DEFAULT Reset the memory allocation policy to the system default.

HWLOC_MEMBIND_FIRSTTOUCH Allocate memory but do not immediately bind it to a specific locality. Instead, each page in the allocation is bound only when it is first touched. Pages are individually bound to the local NUMA node of the first thread that touches it.

HWLOC_MEMBIND_BIND Allocate memory on the specified nodes.

HWLOC_MEMBIND_INTERLEAVE Allocate memory on the given nodes in an interleaved / round-robin manner. The precise layout of the memory across multiple NUMA nodes is OS/system specific. Interleaving can be useful when threads distributed across the specified NUMA nodes will all be accessing the whole memory range concurrently, since the interleave will then balance the memory references.

HWLOC_MEMBIND_REPLICATE Replicate memory on the given nodes; reads from this memory will attempt to be serviced from the NUMA node local to the reading thread. Replicating can be useful when multiple threads from the specified NUMA nodes will be sharing the same read-only data. This policy can only be used with existing memory allocations (i.e., the `hwloc_set_*membind*()` functions); it cannot be used with functions that allocate new memory (i.e., the `hwloc_alloc*()` functions).

HWLOC_MEMBIND_NEXTTOUCH For each page bound with this policy, by next time it is touched (and next time only), it is moved from its current location to the local NUMA node of the thread where the memory reference occurred (if it needs to be moved at all).

HWLOC_MEMBIND_MIXED Returned by `hwloc_get_*membind*()` functions when multiple threads or parts of a memory area have differing memory binding policies.

14.13.3 Function Documentation

14.13.3.1 HWLOC_DECLSPEC void* hwloc_alloc (hwloc_topology_t topology, size_t len)

Allocate some memory.

This is equivalent to `malloc()`, except that it tries to allocate page-aligned memory from the OS.

Note

The allocated memory should be freed with `hwloc_free()`.

14.13.3.2 **HWLOC_DECLSPEC** void* hwloc_alloc_membind (hwloc_topology_t topology, size_t len, hwloc_const_cpuset_t cpuset, hwloc_membind_policy_t policy, int flags)

Allocate some memory on memory nodes near the given physical cpuset *cpuset*.

Returns

NULL with *errno* set to ENOSYS if the action is not supported and HWLOC_MEMBIND_STRICT is given
 NULL with *errno* set to EXDEV if the binding cannot be enforced and HWLOC_MEMBIND_STRICT is given

Note

The allocated memory should be freed with [hwloc_free\(\)](#).

14.13.3.3 **HWLOC_DECLSPEC** void* hwloc_alloc_membind_nodest (hwloc_topology_t topology, size_t len, hwloc_const_nodest_t nodest, hwloc_membind_policy_t policy, int flags)

Allocate some memory on the given physical nodest *nodest*.

Returns

NULL with *errno* set to ENOSYS if the action is not supported and HWLOC_MEMBIND_STRICT is given
 NULL with *errno* set to EXDEV if the binding cannot be enforced and HWLOC_MEMBIND_STRICT is given

Note

The allocated memory should be freed with [hwloc_free\(\)](#).

14.13.3.4 **HWLOC_DECLSPEC** int hwloc_free (hwloc_topology_t topology, void * addr, size_t len)

Free memory that was previously allocated by [hwloc_alloc\(\)](#) or [hwloc_alloc_membind\(\)](#).

14.13.3.5 **HWLOC_DECLSPEC** int hwloc_get_area_membind (hwloc_topology_t topology, const void * addr, size_t len, hwloc_cpuset_t cpuset, hwloc_membind_policy_t * policy, int flags)

Query the CPUs near the physical NUMA node(s) and binding policy of the memory identified by (*addr*, *len*).

This function has two output parameters: *cpuset* and *policy*. The values returned in these parameters depend on both the *flags* passed in and the memory binding policies and nodesets of the pages in the address range.

If HWLOC_MEMBIND_STRICT is specified, the target pages are first checked to see if they all have the same memory binding policy and nodeset. If they do not, -1 is returned and *errno* is set to EXDEV. If they are identical across all pages, the policy is returned in *policy*. *cpuset* is set to the union of CPUs near the NUMA node(s) in the nodeset.

If HWLOC_MEMBIND_STRICT is not specified, the union of all NUMA node(s) containing pages in the address range is calculated. *cpuset* is then set to the CPUs near the NUMA node(s) in this union. If all pages in the target have the same policy, it is returned in *policy*. Otherwise, *policy* is set to HWLOC_MEMBIND_MIXED.

If any other flags are specified, -1 is returned and *errno* is set to EINVAL.

14.13.3.6 **HWLOC_DECLSPEC** int `hwloc_get_area_mbind_nodeset` (`hwloc_topology_t topology`, `const void * addr`, `size_t len`, `hwloc_nodeset_t nodeset`, `hwloc_mbind_policy_t * policy`, `int flags`)

Query the physical NUMA node(s) and binding policy of the memory identified by (`addr`, `len`).

This function has two output parameters: `nodeset` and `policy`. The values returned in these parameters depend on both the `flags` passed in and the memory binding policies and nodesets of the pages in the address range.

If `HWLOC_MEMBIND_STRICT` is specified, the target pages are first checked to see if they all have the same memory binding policy and nodeset. If they do not, -1 is returned and `errno` is set to `EXDEV`. If they are identical across all pages, the `nodeset` and `policy` are returned in `nodeset` and `policy`, respectively.

If `HWLOC_MEMBIND_STRICT` is not specified, `nodeset` is set to the union of all NUMA node(s) containing pages in the address range. If all pages in the target have the same policy, it is returned in `policy`. Otherwise, `policy` is set to `HWLOC_MEMBIND_MIXED`.

If any other flags are specified, -1 is returned and `errno` is set to `EINVAL`.

14.13.3.7 **HWLOC_DECLSPEC** int `hwloc_get_mbind` (`hwloc_topology_t topology`, `hwloc_cpuset_t cpuset`, `hwloc_mbind_policy_t * policy`, `int flags`)

Query the default memory binding policy and physical locality of the current process or thread (the locality is returned in `cpuset` as CPUs near the locality's actual NUMA node(s)).

This function has two output parameters: `cpuset` and `policy`. The values returned in these parameters depend on both the `flags` passed in and the current memory binding policies and nodesets in the queried target.

Passing the `HWLOC_MEMBIND_PROCESS` flag specifies that the query target is the current policies and nodesets for all the threads in the current process. Passing `HWLOC_MEMBIND_THREAD` specifies that the query target is the current policy and nodeset for only the thread invoking this function.

If neither of these flags are passed (which is the most portable method), the process is assumed to be single threaded. This allows `hwloc` to use either process-based OS functions or thread-based OS functions, depending on which are available.

`HWLOC_MEMBIND_STRICT` is only meaningful when `HWLOC_MEMBIND_PROCESS` is also specified. In this case, `hwloc` will check the default memory policies and nodesets for all threads in the process. If they are not identical, -1 is returned and `errno` is set to `EXDEV`. If they are identical, the `policy` is returned in `policy`. `cpuset` is set to the union of CPUs near the NUMA node(s) in the `nodeset`.

Otherwise, if `HWLOC_MEMBIND_PROCESS` is specified (and `HWLOC_MEMBIND_STRICT` is *not* specified), the default nodeset from each thread is logically OR'ed together. `cpuset` is set to the union of CPUs near the NUMA node(s) in the resulting nodeset. If all threads' default policies are the same, `policy` is set to that policy. If they are different, `policy` is set to `HWLOC_MEMBIND_MIXED`.

In the `HWLOC_MEMBIND_THREAD` case (or when neither `HWLOC_MEMBIND_PROCESS` or `HWLOC_MEMBIND_THREAD` is specified), there is only one nodeset and policy. The policy is returned in `policy`; `cpuset` is set to the union of CPUs near the NUMA node(s) in the `nodeset`.

If any other flags are specified, -1 is returned and `errno` is set to `EINVAL`.

14.13.3.8 **HWLOC_DECLSPEC** int `hwloc_get_mbind_nodeset` (`hwloc_topology_t topology`, `hwloc_nodeset_t nodeset`, `hwloc_mbind_policy_t * policy`, `int flags`)

Query the default memory binding policy and physical locality of the current process or thread.

This function has two output parameters: `nodeset` and `policy`. The values returned in these parameters depend on both the `flags` passed in and the current memory binding policies and nodesets in the queried target.

Passing the `HWLOC_MEMBIND_PROCESS` flag specifies that the query target is the current policies and nodesets for all the threads in the current process. Passing `HWLOC_MEMBIND_THREAD` specifies that the query target is the current policy and nodeset for only the thread invoking this function.

If neither of these flags are passed (which is the most portable method), the process is assumed to be single threaded. This allows `hwloc` to use either process-based OS functions or thread-based OS functions, depending on which are available.

`HWLOC_MEMBIND_STRICT` is only meaningful when `HWLOC_MEMBIND_PROCESS` is also specified. In this case, `hwloc` will check the default memory policies and nodesets for all threads in the process. If they are not identical, -1 is returned and `errno` is set to `EXDEV`. If they are identical, the values are returned in `nodeset` and `policy`.

Otherwise, if `HWLOC_MEMBIND_PROCESS` is specified (and `HWLOC_MEMBIND_STRICT` is *not* specified), `nodeset` is set to the logical OR of all threads' default nodeset. If all threads' default policies are the same, `policy` is set to that policy. If they are different, `policy` is set to `HWLOC_MEMBIND_MIXED`.

In the `HWLOC_MEMBIND_THREAD` case (or when neither `HWLOC_MEMBIND_PROCESS` or `HWLOC_MEMBIND_THREAD` is specified), there is only one nodeset and policy; they are returned in `nodeset` and `policy`, respectively.

If any other flags are specified, -1 is returned and `errno` is set to `EINVAL`.

14.13.3.9 `HWLOC_DECLSPEC int hwloc_get_proc_mbind (hwloc_topology_t topology, hwloc_pid_t pid, hwloc_cpuset_t cpuset, hwloc_mbind_policy_t * policy, int flags)`

Query the default memory binding policy and physical locality of the specified process (the locality is returned in `cpuset` as CPUs near the locality's actual NUMA node(s)).

This function has two output parameters: `cpuset` and `policy`. The values returned in these parameters depend on both the `flags` passed in and the current memory binding policies and nodesets in the queried target.

Passing the `HWLOC_MEMBIND_PROCESS` flag specifies that the query target is the current policies and nodesets for all the threads in the specified process. If `HWLOC_MEMBIND_PROCESS` is not specified (which is the most portable method), the process is assumed to be single threaded. This allows `hwloc` to use either process-based OS functions or thread-based OS functions, depending on which are available.

Note that it does not make sense to pass `HWLOC_MEMBIND_THREAD` to this function.

If `HWLOC_MEMBIND_STRICT` is specified, `hwloc` will check the default memory policies and nodesets for all threads in the specified process. If they are not identical, -1 is returned and `errno` is set to `EXDEV`. If they are identical, the policy is returned in `policy`. `cpuset` is set to the union of CPUs near the NUMA node(s) in the nodeset.

Otherwise, the default nodeset from each thread is logically OR'ed together. `cpuset` is set to the union of CPUs near the NUMA node(s) in the resulting nodeset. If all threads' default policies are the same, `policy` is set to that policy. If they are different, `policy` is set to `HWLOC_MEMBIND_MIXED`.

If any other flags are specified, -1 is returned and `errno` is set to `EINVAL`.

Note

`hwloc_pid_t` is `pid_t` on Unix platforms, and `HANDLE` on native Windows platforms.

14.13.3.10 `HWLOC_DECLSPEC int hwloc_get_proc_mbind_nodeset (hwloc_topology_t topology, hwloc_pid_t pid, hwloc_nodeset_t nodeset, hwloc_mbind_policy_t * policy, int flags)`

Query the default memory binding policy and physical locality of the specified process.

This function has two output parameters: `nodeset` and `policy`. The values returned in these parameters depend on both the `flags` passed in and the current memory binding policies and nodesets in the queried target.

Passing the `HWLOC_MEMBIND_PROCESS` flag specifies that the query target is the current policies and nodesets for all the threads in the specified process. If `HWLOC_MEMBIND_PROCESS` is not specified (which is the most portable method), the process is assumed to be single threaded. This allows `hwloc` to use either process-based OS functions or thread-based OS functions, depending on which are available.

Note that it does not make sense to pass `HWLOC_MEMBIND_THREAD` to this function.

If `HWLOC_MEMBIND_STRICT` is specified, `hwloc` will check the default memory policies and nodesets for all threads in the specified process. If they are not identical, -1 is returned and `errno` is set to `EXDEV`. If they are identical, the values are returned in `nodeset` and `policy`.

Otherwise, `nodeset` is set to the logical OR of all threads' default nodeset. If all threads' default policies are the same, `policy` is set to that policy. If they are different, `policy` is set to `HWLOC_MEMBIND_MIXED`.

If any other flags are specified, -1 is returned and `errno` is set to `EINVAL`.

Note

`hwloc_pid_t` is `pid_t` on Unix platforms, and `HANDLE` on native Windows platforms.

14.13.3.11 `HWLOC_DECLSPEC int hwloc_set_area_mbind (hwloc_topology_t topology, const void * addr, size_t len, hwloc_const_cpuset_t cpuset, hwloc_membind_policy_t policy, int flags)`

Bind the already-allocated memory identified by `(addr, len)` to the NUMA node(s) near physical `cpuset`.

Returns

- 1 with `errno` set to `ENOSYS` if the action is not supported
- 1 with `errno` set to `EXDEV` if the binding cannot be enforced

14.13.3.12 `HWLOC_DECLSPEC int hwloc_set_area_mbind_nodeset (hwloc_topology_t topology, const void * addr, size_t len, hwloc_const_nodeset_t nodeset, hwloc_membind_policy_t policy, int flags)`

Bind the already-allocated memory identified by `(addr, len)` to the NUMA node(s) in physical `nodeset`.

Returns

- 1 with `errno` set to `ENOSYS` if the action is not supported
- 1 with `errno` set to `EXDEV` if the binding cannot be enforced

14.13.3.13 `HWLOC_DECLSPEC int hwloc_set_mbind (hwloc_topology_t topology, hwloc_const_cpuset_t cpuset, hwloc_membind_policy_t policy, int flags)`

Set the default memory binding policy of the current process or thread to prefer the NUMA node(s) near the specified physical `cpuset`.

If neither `HWLOC_MEMBIND_PROCESS` nor `HWLOC_MEMBIND_THREAD` is specified, the current process is assumed to be single-threaded. This is the most portable form as it permits `hwloc` to use either process-based OS functions or thread-based OS functions, depending on which are available.

Returns

- 1 with `errno` set to `ENOSYS` if the action is not supported
- 1 with `errno` set to `EXDEV` if the binding cannot be enforced

14.13.3.14 **HWLOC_DECLSPEC** int `hwloc_set_mbind_nodest`(`hwloc_topology_t topology`, `hwloc_const_nodest_t nodest`, `hwloc_mbind_policy_t policy`, int `flags`)

Set the default memory binding policy of the current process or thread to prefer the NUMA node(s) specified by physical `nodest`.

If neither `HWLOC_MEBIND_PROCESS` nor `HWLOC_MEBIND_THREAD` is specified, the current process is assumed to be single-threaded. This is the most portable form as it permits `hwloc` to use either process-based OS functions or thread-based OS functions, depending on which are available.

Returns

- 1 with `errno` set to `ENOSYS` if the action is not supported
- 1 with `errno` set to `EXDEV` if the binding cannot be enforced

14.13.3.15 **HWLOC_DECLSPEC** int `hwloc_set_proc_mbind`(`hwloc_topology_t topology`, `hwloc_pid_t pid`, `hwloc_const_cpuset_t cpuset`, `hwloc_mbind_policy_t policy`, int `flags`)

Set the default memory binding policy of the specified process to prefer the NUMA node(s) near the specified physical `cpuset`.

Returns

- 1 with `errno` set to `ENOSYS` if the action is not supported
- 1 with `errno` set to `EXDEV` if the binding cannot be enforced

Note

`hwloc_pid_t` is `pid_t` on Unix platforms, and `HANDLE` on native Windows platforms.

14.13.3.16 **HWLOC_DECLSPEC** int `hwloc_set_proc_mbind_nodest`(`hwloc_topology_t topology`, `hwloc_pid_t pid`, `hwloc_const_nodest_t nodest`, `hwloc_mbind_policy_t policy`, int `flags`)

Set the default memory binding policy of the specified process to prefer the NUMA node(s) specified by physical `nodest`.

Returns

- 1 with `errno` set to `ENOSYS` if the action is not supported
- 1 with `errno` set to `EXDEV` if the binding cannot be enforced

Note

`hwloc_pid_t` is `pid_t` on Unix platforms, and `HANDLE` on native Windows platforms.

14.14 Object Type Helpers

Functions

- static `__hwloc_inline` int `hwloc_get_type_or_below_depth` (`hwloc_topology_t` topology, `hwloc_obj_type_t` type) `_`
`_hwloc_attribute_pure`
- static `__hwloc_inline` int `hwloc_get_type_or_above_depth` (`hwloc_topology_t` topology, `hwloc_obj_type_t` type) `_`
`_hwloc_attribute_pure`

14.14.1 Detailed Description

Be sure to see the figure in [Terms and Definitions](#) that shows a complete topology tree, including depths, child/sibling/-cousin relationships, and an example of an asymmetric topology where one socket has fewer caches than its peers.

14.14.2 Function Documentation

14.14.2.1 `static __hwloc_inline` int `hwloc_get_type_or_above_depth` (`hwloc_topology_t` topology, `hwloc_obj_type_t` type)
[static]

Returns the depth of objects of type `type` or above.

If no object of this type is present on the underlying architecture, the function returns the depth of the first "present" object typically containing `type`.

If some objects of the given type exist in different levels, for instance L1 and L2 caches, the function returns `HWLOC_TYPE_DEPTH_MULTIPLE`.

14.14.2.2 `static __hwloc_inline` int `hwloc_get_type_or_below_depth` (`hwloc_topology_t` topology, `hwloc_obj_type_t` type)
[static]

Returns the depth of objects of type `type` or below.

If no object of this type is present on the underlying architecture, the function returns the depth of the first "present" object typically found inside `type`.

If some objects of the given type exist in different levels, for instance L1 and L2 caches, the function returns `HWLOC_TYPE_DEPTH_MULTIPLE`.

14.15 Basic Traversal Helpers

Functions

- static `__hwloc_inline hwloc_obj_t hwloc_get_root_obj (hwloc_topology_t topology) __hwloc_attribute_pure`
- static `__hwloc_inline hwloc_obj_t hwloc_get_ancestor_obj_by_depth (hwloc_topology_t topology __hwloc_attribute_unused, unsigned depth, hwloc_obj_t obj) __hwloc_attribute_pure`
- static `__hwloc_inline hwloc_obj_t hwloc_get_ancestor_obj_by_type (hwloc_topology_t topology __hwloc_attribute_unused, hwloc_obj_type_t type, hwloc_obj_t obj) __hwloc_attribute_pure`
- static `__hwloc_inline hwloc_obj_t hwloc_get_next_obj_by_depth (hwloc_topology_t topology, unsigned depth, hwloc_obj_t prev)`
- static `__hwloc_inline hwloc_obj_t hwloc_get_next_obj_by_type (hwloc_topology_t topology, hwloc_obj_type_t type, hwloc_obj_t prev)`
- static `__hwloc_inline hwloc_obj_t hwloc_get_parent_obj_by_os_index (hwloc_topology_t topology, unsigned os_index) __hwloc_attribute_pure`
- static `__hwloc_inline hwloc_obj_t hwloc_get_next_child (hwloc_topology_t topology __hwloc_attribute_unused, hwloc_obj_t parent, hwloc_obj_t prev)`
- static `__hwloc_inline hwloc_obj_t hwloc_get_common_ancestor_obj (hwloc_topology_t topology __hwloc_attribute_unused, hwloc_obj_t obj1, hwloc_obj_t obj2) __hwloc_attribute_pure`
- static `__hwloc_inline int hwloc_obj_is_in_subtree (hwloc_topology_t topology __hwloc_attribute_unused, hwloc_obj_t obj, hwloc_obj_t subtree_root) __hwloc_attribute_pure`

14.15.1 Detailed Description

Be sure to see the figure in [Terms and Definitions](#) that shows a complete topology tree, including depths, child/sibling/-cousin relationships, and an example of an asymmetric topology where one socket has fewer caches than its peers.

14.15.2 Function Documentation

14.15.2.1 static `__hwloc_inline hwloc_obj_t hwloc_get_ancestor_obj_by_depth (hwloc_topology_t topology __hwloc_attribute_unused, unsigned depth, hwloc_obj_t obj) [static]`

Returns the ancestor object of `obj` at depth `depth`.

14.15.2.2 static `__hwloc_inline hwloc_obj_t hwloc_get_ancestor_obj_by_type (hwloc_topology_t topology __hwloc_attribute_unused, hwloc_obj_type_t type, hwloc_obj_t obj) [static]`

Returns the ancestor object of `obj` with type `type`.

14.15.2.3 static `__hwloc_inline hwloc_obj_t hwloc_get_common_ancestor_obj (hwloc_topology_t topology __hwloc_attribute_unused, hwloc_obj_t obj1, hwloc_obj_t obj2) [static]`

Returns the common parent object to objects `lvl1` and `lvl2`.

14.15.2.4 static `__hwloc_inline hwloc_obj_t hwloc_get_next_child (hwloc_topology_t topology __hwloc_attribute_unused, hwloc_obj_t parent, hwloc_obj_t prev) [static]`

Return the next child.

If `prev` is `NULL`, return the first child.

```
14.15.2.5 static __hwloc_inline hwloc_obj_t hwloc_get_next_obj_by_depth ( hwloc_topology_t topology, unsigned depth, hwloc_obj_t prev ) [static]
```

Returns the next object at depth `depth`.

If `prev` is `NULL`, return the first object at depth `depth`.

```
14.15.2.6 static __hwloc_inline hwloc_obj_t hwloc_get_next_obj_by_type ( hwloc_topology_t topology, hwloc_obj_type_t type, hwloc_obj_t prev ) [static]
```

Returns the next object of type `type`.

If `prev` is `NULL`, return the first object at type `type`. If there are multiple or no depth for given type, return `NULL` and let the caller fallback to [hwloc_get_next_obj_by_depth\(\)](#).

```
14.15.2.7 static __hwloc_inline hwloc_obj_t hwloc_get_pu_obj_by_os_index ( hwloc_topology_t topology, unsigned os_index ) [static]
```

Returns the object of type [HWLOC_OBJ_PU](#) with `os_index`.

Note

The `os_index` field of object should most of the times only be used for pretty-printing purpose. Type [HWLOC_OBJ_PU](#) is the only case where `os_index` could actually be useful, when manually binding to processors. However, using CPU sets to hide this complexity should often be preferred.

```
14.15.2.8 static __hwloc_inline hwloc_obj_t hwloc_get_root_obj ( hwloc_topology_t topology ) [static]
```

Returns the top-object of the topology-tree.

Its type is typically [HWLOC_OBJ_MACHINE](#) but it could be different for complex topologies. This function replaces the old deprecated `hwloc_get_system_obj()`.

```
14.15.2.9 static __hwloc_inline int hwloc_obj_is_in_subtree ( hwloc_topology_t topology __hwloc_attribute_unused, hwloc_obj_t obj, hwloc_obj_t subtree_root ) [static]
```

Returns true if `obj` is inside the subtree beginning with `subtree_root`.

Note

This function assumes that both `obj` and `subtree_root` have a `cpuset`.

14.16 Finding Objects Inside a CPU set

Functions

- static `__hwloc_inline hwloc_obj_t hwloc_get_first_largest_obj_inside_cpuset` (`hwloc_topology_t topology`, `hwloc_const_cpuset_t set`)
- `HWLOC_DECLSPEC int hwloc_get_largest_objs_inside_cpuset` (`hwloc_topology_t topology`, `hwloc_const_cpuset_t set`, `hwloc_obj_t *__hwloc_restrict objs`, `int max`)
- static `__hwloc_inline hwloc_obj_t hwloc_get_next_obj_inside_cpuset_by_depth` (`hwloc_topology_t topology`, `hwloc_const_cpuset_t set`, `unsigned depth`, `hwloc_obj_t prev`)
- static `__hwloc_inline hwloc_obj_t hwloc_get_next_obj_inside_cpuset_by_type` (`hwloc_topology_t topology`, `hwloc_const_cpuset_t set`, `hwloc_obj_type_t type`, `hwloc_obj_t prev`)
- static `__hwloc_inline hwloc_obj_t hwloc_get_obj_inside_cpuset_by_depth` (`hwloc_topology_t topology`, `hwloc_const_cpuset_t set`, `unsigned depth`, `unsigned idx`) `__hwloc_attribute_pure`
- static `__hwloc_inline hwloc_obj_t hwloc_get_obj_inside_cpuset_by_type` (`hwloc_topology_t topology`, `hwloc_const_cpuset_t set`, `hwloc_obj_type_t type`, `unsigned idx`) `__hwloc_attribute_pure`
- static `__hwloc_inline unsigned hwloc_get_nbobjs_inside_cpuset_by_depth` (`hwloc_topology_t topology`, `hwloc_const_cpuset_t set`, `unsigned depth`) `__hwloc_attribute_pure`
- static `__hwloc_inline int hwloc_get_nbobjs_inside_cpuset_by_type` (`hwloc_topology_t topology`, `hwloc_const_cpuset_t set`, `hwloc_obj_type_t type`) `__hwloc_attribute_pure`

14.16.1 Detailed Description

14.16.2 Function Documentation

14.16.2.1 `static __hwloc_inline hwloc_obj_t hwloc_get_first_largest_obj_inside_cpuset` (`hwloc_topology_t topology`, `hwloc_const_cpuset_t set`) `[static]`

Get the first largest object included in the given cpuset `set`.

Returns

the first object that is included in `set` and whose parent is not.

This is convenient for iterating over all largest objects within a CPU set by doing a loop getting the first largest object and clearing its CPU set from the remaining CPU set.

14.16.2.2 `HWLOC_DECLSPEC int hwloc_get_largest_objs_inside_cpuset` (`hwloc_topology_t topology`, `hwloc_const_cpuset_t set`, `hwloc_obj_t *__hwloc_restrict objs`, `int max`)

Get the set of largest objects covering exactly a given cpuset `set`.

Returns

the number of objects returned in `objs`.

14.16.2.3 `static __hwloc_inline unsigned hwloc_get_nbobjs_inside_cpuset_by_depth` (`hwloc_topology_t topology`, `hwloc_const_cpuset_t set`, `unsigned depth`) `[static]`

Return the number of objects at depth `depth` included in CPU set `set`.

```
14.16.2.4 static __hwloc_inline int hwloc_get_nobjs_inside_cpuset_by_type ( hwloc_topology_t topology,  
hwloc_const_cpuset_t set, hwloc_obj_type_t type ) [static]
```

Return the number of objects of type `type` included in CPU set `set`.

If no object for that type exists inside CPU set `set`, 0 is returned. If there are several levels with objects of that type inside CPU set `set`, -1 is returned.

```
14.16.2.5 static __hwloc_inline hwloc_obj_t hwloc_get_next_obj_inside_cpuset_by_depth ( hwloc_topology_t topology,  
hwloc_const_cpuset_t set, unsigned depth, hwloc_obj_t prev ) [static]
```

Return the next object at depth `depth` included in CPU set `set`.

If `prev` is NULL, return the first object at depth `depth` included in `set`. The next invocation should pass the previous return value in `prev` so as to obtain the next object in `set`.

```
14.16.2.6 static __hwloc_inline hwloc_obj_t hwloc_get_next_obj_inside_cpuset_by_type ( hwloc_topology_t topology,  
hwloc_const_cpuset_t set, hwloc_obj_type_t type, hwloc_obj_t prev ) [static]
```

Return the next object of type `type` included in CPU set `set`.

If there are multiple or no depth for given type, return NULL and let the caller fallback to [hwloc_get_next_obj_inside_cpuset_by_depth\(\)](#).

```
14.16.2.7 static __hwloc_inline hwloc_obj_t hwloc_get_obj_inside_cpuset_by_depth ( hwloc_topology_t topology,  
hwloc_const_cpuset_t set, unsigned depth, unsigned idx ) [static]
```

Return the (logically) `idx`-th object at depth `depth` included in CPU set `set`.

```
14.16.2.8 static __hwloc_inline hwloc_obj_t hwloc_get_obj_inside_cpuset_by_type ( hwloc_topology_t topology,  
hwloc_const_cpuset_t set, hwloc_obj_type_t type, unsigned idx ) [static]
```

Return the `idx`-th object of type `type` included in CPU set `set`.

If there are multiple or no depth for given type, return NULL and let the caller fallback to [hwloc_get_obj_inside_cpuset_by_depth\(\)](#).

14.17 Finding a single Object covering at least CPU set

Functions

- static `__hwloc_inline hwloc_obj_t hwloc_get_child_covering_cpuset (hwloc_topology_t topology, __hwloc_attribute_unused, hwloc_const_cpuset_t set, hwloc_obj_t parent) __hwloc_attribute_pure`
- static `__hwloc_inline hwloc_obj_t hwloc_get_obj_covering_cpuset (hwloc_topology_t topology, hwloc_const_cpuset_t set) __hwloc_attribute_pure`

14.17.1 Detailed Description

14.17.2 Function Documentation

14.17.2.1 `static __hwloc_inline hwloc_obj_t hwloc_get_child_covering_cpuset (hwloc_topology_t topology, __hwloc_attribute_unused, hwloc_const_cpuset_t set, hwloc_obj_t parent) [static]`

Get the child covering at least CPU set `set`.

Returns

NULL if no child matches or if `set` is empty.

14.17.2.2 `static __hwloc_inline hwloc_obj_t hwloc_get_obj_covering_cpuset (hwloc_topology_t topology, hwloc_const_cpuset_t set) [static]`

Get the lowest object covering at least CPU set `set`.

Returns

NULL if no object matches or if `set` is empty.

14.18 Finding a set of similar Objects covering at least a CPU set

Functions

- static `__hwloc_inline hwloc_obj_t hwloc_get_next_obj_covering_cpuset_by_depth` (`hwloc_topology_t topology`, `hwloc_const_cpuset_t set`, unsigned `depth`, `hwloc_obj_t prev`)
- static `__hwloc_inline hwloc_obj_t hwloc_get_next_obj_covering_cpuset_by_type` (`hwloc_topology_t topology`, `hwloc_const_cpuset_t set`, `hwloc_obj_type_t type`, `hwloc_obj_t prev`)

14.18.1 Detailed Description

14.18.2 Function Documentation

14.18.2.1 `static __hwloc_inline hwloc_obj_t hwloc_get_next_obj_covering_cpuset_by_depth` (`hwloc_topology_t topology`, `hwloc_const_cpuset_t set`, unsigned `depth`, `hwloc_obj_t prev`) [`static`]

Iterate through same-depth objects covering at least CPU set `set`.

If object `prev` is `NULL`, return the first object at depth `depth` covering at least part of CPU set `set`. The next invocation should pass the previous return value in `prev` so as to obtain the next object covering at least another part of `set`.

14.18.2.2 `static __hwloc_inline hwloc_obj_t hwloc_get_next_obj_covering_cpuset_by_type` (`hwloc_topology_t topology`, `hwloc_const_cpuset_t set`, `hwloc_obj_type_t type`, `hwloc_obj_t prev`) [`static`]

Iterate through same-type objects covering at least CPU set `set`.

If object `prev` is `NULL`, return the first object of type `type` covering at least part of CPU set `set`. The next invocation should pass the previous return value in `prev` so as to obtain the next object of type `type` covering at least another part of `set`.

If there are no or multiple depths for type `type`, `NULL` is returned. The caller may fallback to [hwloc_get_next_obj_covering_cpuset_by_depth\(\)](#) for each depth.

14.19 Cache-specific Finding Helpers

Functions

- static `__hwloc_inline hwloc_obj_t hwloc_get_cache_covering_cpuset` (`hwloc_topology_t topology`, `hwloc_const_cpuset_t set`) `__hwloc_attribute_pure`
- static `__hwloc_inline hwloc_obj_t hwloc_get_shared_cache_covering_obj` (`hwloc_topology_t topology` `__hwloc_attribute_unused`, `hwloc_obj_t obj`) `__hwloc_attribute_pure`

14.19.1 Detailed Description

14.19.2 Function Documentation

14.19.2.1 `static __hwloc_inline hwloc_obj_t hwloc_get_cache_covering_cpuset` (`hwloc_topology_t topology`, `hwloc_const_cpuset_t set`) [`static`]

Get the first cache covering a cpuset `set`.

Returns

NULL if no cache matches

14.19.2.2 `static __hwloc_inline hwloc_obj_t hwloc_get_shared_cache_covering_obj` (`hwloc_topology_t topology` `__hwloc_attribute_unused`, `hwloc_obj_t obj`) [`static`]

Get the first cache shared between an object and somebody else.

Returns

NULL if no cache matches or if an invalid object is given.

14.20 Advanced Traversal Helpers

Functions

- HWLOC_DECLSPEC unsigned `hwloc_get_closest_objs` (`hwloc_topology_t` topology, `hwloc_obj_t` src, `hwloc_obj_t *` __hwloc_restrict objs, unsigned max)
- static __hwloc_inline `hwloc_obj_t hwloc_get_obj_below_by_type` (`hwloc_topology_t` topology, `hwloc_obj_type_t` type1, unsigned idx1, `hwloc_obj_type_t` type2, unsigned idx2) __hwloc_attribute_pure
- static __hwloc_inline `hwloc_obj_t hwloc_get_obj_below_array_by_type` (`hwloc_topology_t` topology, int nr, `hwloc_obj_type_t *` typev, unsigned *idxv) __hwloc_attribute_pure

14.20.1 Detailed Description

Be sure to see the figure in [Terms and Definitions](#) that shows a complete topology tree, including depths, child/sibling/cousin relationships, and an example of an asymmetric topology where one socket has fewer caches than its peers.

14.20.2 Function Documentation

14.20.2.1 HWLOC_DECLSPEC unsigned `hwloc_get_closest_objs` (`hwloc_topology_t` topology, `hwloc_obj_t` src, `hwloc_obj_t *` __hwloc_restrict objs, unsigned max)

Do a depth-first traversal of the topology to find and sort.

all objects that are at the same depth than src. Report in objs up to max physically closest ones to src.

Returns

the number of objects returned in objs.
0 if src is an I/O object.

14.20.2.2 static __hwloc_inline `hwloc_obj_t hwloc_get_obj_below_array_by_type` (`hwloc_topology_t` topology, int nr, `hwloc_obj_type_t *` typev, unsigned * idxv) [static]

Find an object below a chain of objects specified by types and indexes.

This is a generalized version of `hwloc_get_obj_below_by_type()`.

Arrays typev and idxv must contain nr types and indexes.

Start from the top system object and walk the arrays typev and idxv. For each type and logical index couple in the arrays, look under the previously found object to find the index-th object of the given type. Indexes are specified within the parent, not withing the entire system.

For instance, if nr is 3, typev contains NODE, SOCKET and CORE, and idxv contains 0, 1 and 2, return the third core object below the second socket below the first NUMA node.

14.20.2.3 static __hwloc_inline `hwloc_obj_t hwloc_get_obj_below_by_type` (`hwloc_topology_t` topology, `hwloc_obj_type_t` type1, unsigned idx1, `hwloc_obj_type_t` type2, unsigned idx2) [static]

Find an object below another object, both specified by types and indexes.

Start from the top system object and find object of type type1 and logical index idx1. Then look below this object and find another object of type type2 and logical index idx2. Indexes are specified within the parent, not withing the entire system.

For instance, if type1 is SOCKET, idx1 is 2, type2 is CORE and idx2 is 3, return the fourth core object below the third socket.

14.21 Binding Helpers

Functions

- static `__hwloc_inline void hwloc_distributev (hwloc_topology_t topology, hwloc_obj_t *root, unsigned n_roots, hwloc_cpuset_t *cpuset, unsigned n, unsigned until)`
- static `__hwloc_inline void hwloc_distribute (hwloc_topology_t topology, hwloc_obj_t root, hwloc_cpuset_t *cpuset, unsigned n, unsigned until)`
- static `__hwloc_inline void * hwloc_alloc_membind_policy_nodeset (hwloc_topology_t topology, size_t len, hwloc_const_nodeset_t nodeset, hwloc_membind_policy_t policy, int flags)`
- static `__hwloc_inline void * hwloc_alloc_membind_policy (hwloc_topology_t topology, size_t len, hwloc_const_cpuset_t cpuset, hwloc_membind_policy_t policy, int flags)`

14.21.1 Detailed Description

14.21.2 Function Documentation

14.21.2.1 `static __hwloc_inline void* hwloc_alloc_membind_policy (hwloc_topology_t topology, size_t len, hwloc_const_cpuset_t cpuset, hwloc_membind_policy_t policy, int flags) [static]`

Allocate some memory on the memory nodes near given cpuset `cpuset`.

This is similar to `hwloc_alloc_membind_policy_nodeset`, but for a given cpuset.

14.21.2.2 `static __hwloc_inline void* hwloc_alloc_membind_policy_nodeset (hwloc_topology_t topology, size_t len, hwloc_const_nodeset_t nodeset, hwloc_membind_policy_t policy, int flags) [static]`

Allocate some memory on the given nodeset `nodeset`.

This is similar to `hwloc_alloc_membind` except that it is allowed to change the current memory binding policy, thus providing more binding support, at the expense of changing the current state.

14.21.2.3 `static __hwloc_inline void hwloc_distribute (hwloc_topology_t topology, hwloc_obj_t root, hwloc_cpuset_t *cpuset, unsigned n, unsigned until) [static]`

14.21.2.4 `static __hwloc_inline void hwloc_distributev (hwloc_topology_t topology, hwloc_obj_t * roots, unsigned n_roots, hwloc_cpuset_t *cpuset, unsigned n, unsigned until) [static]`

Distribute `n` items over the topology under `root`.

Distribute `n` items over the topology under `roots`.

Array `cpuset` will be filled with `n` cpusets recursively distributed linearly over the topology under `root`, down to depth `until` (which can be `INT_MAX` to distribute down to the finest level).

This is typically useful when an application wants to distribute `n` threads over a machine, giving each of them as much private cache as possible and keeping them locally in number order.

The caller may typically want to also call `hwloc_bitmap_singlify()` before binding a thread so that it does not move at all.

This is the same as `hwloc_distribute`, but takes an array of roots instead of just one root.

14.22 Cpuset Helpers

Functions

- static `__hwloc_inline`
`hwloc_const_cpuset_t hwloc_topology_get_complete_cpuset (hwloc_topology_t topology) __hwloc_attribute_pure`
- static `__hwloc_inline`
`hwloc_const_cpuset_t hwloc_topology_get_topology_cpuset (hwloc_topology_t topology) __hwloc_attribute_pure`
- static `__hwloc_inline`
`hwloc_const_cpuset_t hwloc_topology_get_online_cpuset (hwloc_topology_t topology) __hwloc_attribute_pure`
- static `__hwloc_inline`
`hwloc_const_cpuset_t hwloc_topology_get_allowed_cpuset (hwloc_topology_t topology) __hwloc_attribute_pure`

14.22.1 Detailed Description

14.22.2 Function Documentation

14.22.2.1 `static __hwloc_inline hwloc_const_cpuset_t hwloc_topology_get_allowed_cpuset (hwloc_topology_t topology)`
[static]

Get allowed CPU set.

Returns

the CPU set of allowed logical processors of the system. If the topology is the result of a combination of several systems, NULL is returned.

Note

The returned cpuset is not newly allocated and should thus not be changed or freed, `hwloc_cpuset_dup` must be used to obtain a local copy.

14.22.2.2 `static __hwloc_inline hwloc_const_cpuset_t hwloc_topology_get_complete_cpuset (hwloc_topology_t topology)`
[static]

Get complete CPU set.

Returns

the complete CPU set of logical processors of the system. If the topology is the result of a combination of several systems, NULL is returned.

Note

The returned cpuset is not newly allocated and should thus not be changed or freed; `hwloc_cpuset_dup` must be used to obtain a local copy.

```
14.22.2.3 static __hwloc_inline hwloc_const_cpuset_t hwloc_topology_get_online_cpuset ( hwloc_topology_t topology )  
        [static]
```

Get online CPU set.

Returns

the CPU set of online logical processors of the system. If the topology is the result of a combination of several systems, NULL is returned.

Note

The returned cpuset is not newly allocated and should thus not be changed or freed; `hwloc_cpuset_dup` must be used to obtain a local copy.

```
14.22.2.4 static __hwloc_inline hwloc_const_cpuset_t hwloc_topology_get_topology_cpuset ( hwloc_topology_t topology )  
        [static]
```

Get topology CPU set.

Returns

the CPU set of logical processors of the system for which hwloc provides topology information. This is equivalent to the cpuset of the system object. If the topology is the result of a combination of several systems, NULL is returned.

Note

The returned cpuset is not newly allocated and should thus not be changed or freed; `hwloc_cpuset_dup` must be used to obtain a local copy.

14.23 Nodeset Helpers

Functions

- static `__hwloc_inline`
`hwloc_const_nodeset_t hwloc_topology_get_complete_nodeset (hwloc_topology_t topology) __hwloc_attribute__pure`
- static `__hwloc_inline`
`hwloc_const_nodeset_t hwloc_topology_get_topology_nodeset (hwloc_topology_t topology) __hwloc_attribute__pure`
- static `__hwloc_inline`
`hwloc_const_nodeset_t hwloc_topology_get_allowed_nodeset (hwloc_topology_t topology) __hwloc_attribute__pure`

14.23.1 Detailed Description

14.23.2 Function Documentation

14.23.2.1 `static __hwloc_inline hwloc_const_nodeset_t hwloc_topology_get_allowed_nodeset (hwloc_topology_t topology) [static]`

Get allowed node set.

Returns

the node set of allowed memory of the system. If the topology is the result of a combination of several systems, NULL is returned.

Note

The returned nodeset is not newly allocated and should thus not be changed or freed, `hwloc_nodeset_dup` must be used to obtain a local copy.

14.23.2.2 `static __hwloc_inline hwloc_const_nodeset_t hwloc_topology_get_complete_nodeset (hwloc_topology_t topology) [static]`

Get complete node set.

Returns

the complete node set of memory of the system. If the topology is the result of a combination of several systems, NULL is returned.

Note

The returned nodeset is not newly allocated and should thus not be changed or freed; `hwloc_nodeset_dup` must be used to obtain a local copy.

```
14.23.2.3 static __hwloc_inline hwloc_const_nodeset_t hwloc_topology_get_topology_nodeset ( hwloc_topology_t topology
) [static]
```

Get topology node set.

Returns

the node set of memory of the system for which hwloc provides topology information. This is equivalent to the nodeset of the system object. If the topology is the result of a combination of several systems, NULL is returned.

Note

The returned nodeset is not newly allocated and should thus not be changed or freed; `hwloc_nodeset_dup` must be used to obtain a local copy.

14.24 Conversion between cpuset and nodeset

Functions

- static `__hwloc_inline void hwloc_cpuset_to_nodeset (hwloc_topology_t topology, hwloc_const_cpuset_t cpuset, hwloc_nodeset_t nodeset)`
- static `__hwloc_inline void hwloc_cpuset_to_nodeset_strict (struct hwloc_topology *topology, hwloc_const_cpuset_t cpuset, hwloc_nodeset_t nodeset)`
- static `__hwloc_inline void hwloc_cpuset_from_nodeset (hwloc_topology_t topology, hwloc_cpuset_t cpuset, hwloc_const_nodeset_t nodeset)`
- static `__hwloc_inline void hwloc_cpuset_from_nodeset_strict (struct hwloc_topology *topology, hwloc_cpuset_t cpuset, hwloc_const_nodeset_t nodeset)`

14.24.1 Detailed Description

There are two semantics for converting cpusets to nodesets depending on how non-NUMA machines are handled.

When manipulating nodesets for memory binding, non-NUMA machines should be considered as having a single NUMA node. The standard conversion routines below should be used so that marking the first bit of the nodeset means that memory should be bound to a non-NUMA whole machine.

When manipulating nodesets as an actual list of NUMA nodes without any need to handle memory binding on non-NUMA machines, the strict conversion routines may be used instead.

14.24.2 Function Documentation

14.24.2.1 `static __hwloc_inline void hwloc_cpuset_from_nodeset (hwloc_topology_t topology, hwloc_cpuset_t cpuset, hwloc_const_nodeset_t nodeset) [static]`

Convert a NUMA node set into a CPU set and handle non-NUMA cases.

If the topology contains no NUMA nodes, the machine is considered as a single memory node, and the following behavior is used: If `nodeset` is empty, `cpuset` will be emptied as well. Otherwise `cpuset` will be entirely filled. This is useful for manipulating memory binding sets.

14.24.2.2 `static __hwloc_inline void hwloc_cpuset_from_nodeset_strict (struct hwloc_topology * topology, hwloc_cpuset_t cpuset, hwloc_const_nodeset_t nodeset) [static]`

Convert a NUMA node set into a CPU set without handling non-NUMA cases.

This is the strict variant of `hwloc_cpuset_from_nodeset`. It does not fix non-NUMA cases. If the topology contains some NUMA nodes, behave exactly the same. However, if the topology contains no NUMA nodes, return an empty `cpuset`.

14.24.2.3 `static __hwloc_inline void hwloc_cpuset_to_nodeset (hwloc_topology_t topology, hwloc_const_cpuset_t cpuset, hwloc_nodeset_t nodeset) [static]`

Convert a CPU set into a NUMA node set and handle non-NUMA cases.

If some NUMA nodes have no CPUs at all, this function never sets their indexes in the output node set, even if a full CPU set is given in input.

If the topology contains no NUMA nodes, the machine is considered as a single memory node, and the following behavior is used: If `cpuset` is empty, `nodeset` will be emptied as well. Otherwise `nodeset` will be entirely filled.

```
14.24.2.4 static __hwloc_inline void hwloc_cpuset_to_nodeset_strict ( struct hwloc_topology * topology, hwloc_const_cpuset_t
    cpuset, hwloc_nodeset_t nodeset ) [static]
```

Convert a CPU set into a NUMA node set without handling non-NUMA cases.

This is the strict variant of [hwloc_cpuset_to_nodeset](#). It does not fix non-NUMA cases. If the topology contains some NUMA nodes, behave exactly the same. However, if the topology contains no NUMA nodes, return an empty nodeset.

14.25 Distances

Functions

- static `__hwloc_inline struct hwloc_distances_s * hwloc_get_whole_distance_matrix_by_depth (hwloc_topology_t topology, unsigned depth)`
- static `__hwloc_inline struct hwloc_distances_s * hwloc_get_whole_distance_matrix_by_type (hwloc_topology_t topology, hwloc_obj_type_t type)`
- static `__hwloc_inline struct hwloc_distances_s * hwloc_get_distance_matrix_covering_obj_by_depth (hwloc_topology_t topology, hwloc_obj_t obj, unsigned depth, unsigned *firstp)`
- static `__hwloc_inline int hwloc_get_latency (hwloc_topology_t topology, hwloc_obj_t obj1, hwloc_obj_t obj2, float *latency, float *reverse_latency)`

14.25.1 Detailed Description

14.25.2 Function Documentation

14.25.2.1 static `__hwloc_inline struct hwloc_distances_s* hwloc_get_distance_matrix_covering_obj_by_depth (hwloc_topology_t topology, hwloc_obj_t obj, unsigned depth, unsigned * firstp)` [static],[read]

Get distances for the given depth and covering some objects.

Return a distance matrix that describes depth `depth` and covers at least object `obj` and all its children.

When looking for the distance between some objects, a common ancestor should be passed in `obj`.

`firstp` is set to logical index of the first object described by the matrix.

The returned structure belongs to the hwloc library. The caller should not modify or free it.

14.25.2.2 static `__hwloc_inline int hwloc_get_latency (hwloc_topology_t topology, hwloc_obj_t obj1, hwloc_obj_t obj2, float * latency, float * reverse_latency)` [static]

Get the latency in both directions between two objects.

Look at ancestor objects from the bottom to the top until one of them contains a distance matrix that matches the objects exactly.

`latency` gets the value from object `obj1` to `obj2`, while `reverse_latency` gets the reverse-direction value, which may be different on some architectures.

Returns

- 1 if no ancestor contains a matching latency matrix.

14.25.2.3 static `__hwloc_inline struct hwloc_distances_s* hwloc_get_whole_distance_matrix_by_depth (hwloc_topology_t topology, unsigned depth)` [static],[read]

Get the distances between all objects at the given depth.

Returns

a distances structure containing a matrix with all distances between all objects at the given depth.

Slot $i+n\text{objs}*j$ contains the distance from the object of logical index i the object of logical index j .

Note

This function only returns matrices covering the whole topology, without any unknown distance value. Those matrices are available in top-level object of the hierarchy. Matrices of lower objects are not reported here since they cover only part of the machine.

The returned structure belongs to the hwloc library. The caller should not modify or free it.

Returns

NULL if no such distance matrix exists.

14.25.2.4 `static __hwloc_inline struct hwloc_distances_s* hwloc_get_whole_distance_matrix_by_type (hwloc_topology_t topology, hwloc_obj_type_t type) [static],[read]`

Get the distances between all objects of a given type.

Returns

a distances structure containing a matrix with all distances between all objects of the given type.

Slot $i+n\text{objs}*j$ contains the distance from the object of logical index i the object of logical index j .

Note

This function only returns matrices covering the whole topology, without any unknown distance value. Those matrices are available in top-level object of the hierarchy. Matrices of lower objects are not reported here since they cover only part of the machine.

The returned structure belongs to the hwloc library. The caller should not modify or free it.

Returns

NULL if no such distance matrix exists.

14.26 Advanced I/O object traversal helpers

Functions

- static `__hwloc_inline hwloc_obj_t hwloc_get_non_io_ancestor_obj (hwloc_topology_t topology, __hwloc_attribute_unused, hwloc_obj_t iobj)`
- static `__hwloc_inline hwloc_obj_t hwloc_get_next_pcidev (hwloc_topology_t topology, hwloc_obj_t prev)`
- static `__hwloc_inline hwloc_obj_t hwloc_get_pcidev_by_busid (hwloc_topology_t topology, unsigned domain, unsigned bus, unsigned dev, unsigned func)`
- static `__hwloc_inline hwloc_obj_t hwloc_get_pcidev_by_busidstring (hwloc_topology_t topology, const char *busid)`
- static `__hwloc_inline hwloc_obj_t hwloc_get_next_osdev (hwloc_topology_t topology, hwloc_obj_t prev)`
- static `__hwloc_inline hwloc_obj_t hwloc_get_next_bridge (hwloc_topology_t topology, hwloc_obj_t prev)`
- static `__hwloc_inline int hwloc_bridge_covers_pcibus (hwloc_obj_t bridge, unsigned domain, unsigned bus)`
- static `__hwloc_inline hwloc_obj_t hwloc_get_hostbridge_by_pcibus (hwloc_topology_t topology, unsigned domain, unsigned bus)`

14.26.1 Detailed Description

14.26.2 Function Documentation

14.26.2.1 `static __hwloc_inline int hwloc_bridge_covers_pcibus (hwloc_obj_t bridge, unsigned domain, unsigned bus)`
`[static]`

14.26.2.2 `static __hwloc_inline hwloc_obj_t hwloc_get_hostbridge_by_pcibus (hwloc_topology_t topology, unsigned domain, unsigned bus)` `[static]`

Find the hostbridge that covers the given PCI bus.

This is useful for finding the locality of a bus because it is the hostbridge parent cpuset.

14.26.2.3 `static __hwloc_inline hwloc_obj_t hwloc_get_next_bridge (hwloc_topology_t topology, hwloc_obj_t prev)`
`[static]`

Get the next bridge in the system.

Returns

the first bridge if `prev` is `NULL`.

14.26.2.4 `static __hwloc_inline hwloc_obj_t hwloc_get_next_osdev (hwloc_topology_t topology, hwloc_obj_t prev)`
`[static]`

Get the next OS device in the system.

Returns

the first OS device if `prev` is `NULL`.

```
14.26.2.5 static __hwloc_inline hwloc_obj_t hwloc_get_next_pcidev ( hwloc_topology_t topology, hwloc_obj_t prev )  
          [static]
```

Get the next PCI device in the system.

Returns

the first PCI device if `prev` is `NULL`.

```
14.26.2.6 static __hwloc_inline hwloc_obj_t hwloc_get_non_io_ancestor_obj ( hwloc_topology_t topology  
          __hwloc_attribute_unused, hwloc_obj_t iobj ) [static]
```

Get the first non-I/O ancestor object.

Given the I/O object `iobj`, find the smallest non-I/O ancestor object. This regular object may then be used for binding because its locality is the same as `iobj`.

```
14.26.2.7 static __hwloc_inline hwloc_obj_t hwloc_get_pcidev_by_busid ( hwloc_topology_t topology, unsigned domain,  
          unsigned bus, unsigned dev, unsigned func ) [static]
```

Find the PCI device object matching the PCI bus id given domain, bus device and function PCI bus id.

```
14.26.2.8 static __hwloc_inline hwloc_obj_t hwloc_get_pcidev_by_busidstring ( hwloc_topology_t topology, const char *  
          busid ) [static]
```

Find the PCI device object matching the PCI bus id given as a string `xxxx:yy:zz.t` or `yy:zz.t`.

14.27 The bitmap API

Macros

- #define `hwloc_bitmap_foreach_begin`(id, bitmap)
- #define `hwloc_bitmap_foreach_end`()

Typedefs

- typedef struct `hwloc_bitmap_s` * `hwloc_bitmap_t`
- typedef struct `hwloc_bitmap_s` * `hwloc_const_bitmap_t`

Functions

- HWLOC_DECLSPEC `hwloc_bitmap_t` `hwloc_bitmap_alloc` (void) `__hwloc_attribute_malloc`
- HWLOC_DECLSPEC `hwloc_bitmap_t` `hwloc_bitmap_alloc_full` (void) `__hwloc_attribute_malloc`
- HWLOC_DECLSPEC void `hwloc_bitmap_free` (`hwloc_bitmap_t` bitmap)
- HWLOC_DECLSPEC `hwloc_bitmap_t` `hwloc_bitmap_dup` (`hwloc_const_bitmap_t` bitmap) `__hwloc_attribute_malloc`
- HWLOC_DECLSPEC void `hwloc_bitmap_copy` (`hwloc_bitmap_t` dst, `hwloc_const_bitmap_t` src)
- HWLOC_DECLSPEC int `hwloc_bitmap_snprintf` (char * `__hwloc_restrict` buf, size_t buflen, `hwloc_const_bitmap_t` bitmap)
- HWLOC_DECLSPEC int `hwloc_bitmap_asprintf` (char **strp, `hwloc_const_bitmap_t` bitmap)
- HWLOC_DECLSPEC int `hwloc_bitmap_sscanf` (`hwloc_bitmap_t` bitmap, const char * `__hwloc_restrict` string)
- HWLOC_DECLSPEC int `hwloc_bitmap_list_snprintf` (char * `__hwloc_restrict` buf, size_t buflen, `hwloc_const_bitmap_t` bitmap)
- HWLOC_DECLSPEC int `hwloc_bitmap_list_asprintf` (char **strp, `hwloc_const_bitmap_t` bitmap)
- HWLOC_DECLSPEC int `hwloc_bitmap_list_sscanf` (`hwloc_bitmap_t` bitmap, const char * `__hwloc_restrict` string)
- HWLOC_DECLSPEC int `hwloc_bitmap_taskset_snprintf` (char * `__hwloc_restrict` buf, size_t buflen, `hwloc_const_bitmap_t` bitmap)
- HWLOC_DECLSPEC int `hwloc_bitmap_taskset_asprintf` (char **strp, `hwloc_const_bitmap_t` bitmap)
- HWLOC_DECLSPEC int `hwloc_bitmap_taskset_sscanf` (`hwloc_bitmap_t` bitmap, const char * `__hwloc_restrict` string)
- HWLOC_DECLSPEC void `hwloc_bitmap_zero` (`hwloc_bitmap_t` bitmap)
- HWLOC_DECLSPEC void `hwloc_bitmap_fill` (`hwloc_bitmap_t` bitmap)
- HWLOC_DECLSPEC void `hwloc_bitmap_only` (`hwloc_bitmap_t` bitmap, unsigned id)
- HWLOC_DECLSPEC void `hwloc_bitmap_allbut` (`hwloc_bitmap_t` bitmap, unsigned id)
- HWLOC_DECLSPEC void `hwloc_bitmap_from_ulong` (`hwloc_bitmap_t` bitmap, unsigned long mask)
- HWLOC_DECLSPEC void `hwloc_bitmap_from_ith_ulong` (`hwloc_bitmap_t` bitmap, unsigned i, unsigned long mask)
- HWLOC_DECLSPEC void `hwloc_bitmap_set` (`hwloc_bitmap_t` bitmap, unsigned id)
- HWLOC_DECLSPEC void `hwloc_bitmap_set_range` (`hwloc_bitmap_t` bitmap, unsigned begin, int end)
- HWLOC_DECLSPEC void `hwloc_bitmap_set_ith_ulong` (`hwloc_bitmap_t` bitmap, unsigned i, unsigned long mask)
- HWLOC_DECLSPEC void `hwloc_bitmap_clr` (`hwloc_bitmap_t` bitmap, unsigned id)
- HWLOC_DECLSPEC void `hwloc_bitmap_clr_range` (`hwloc_bitmap_t` bitmap, unsigned begin, int end)
- HWLOC_DECLSPEC void `hwloc_bitmap_singlify` (`hwloc_bitmap_t` bitmap)
- HWLOC_DECLSPEC unsigned long `hwloc_bitmap_to_ulong` (`hwloc_const_bitmap_t` bitmap) `__hwloc_attribute_pure`

- HWLOC_DECLSPEC unsigned long `hwloc_bitmap_to_ith_ulong` (`hwloc_const_bitmap_t` bitmap, unsigned i) `__hwloc_attribute_pure`
- HWLOC_DECLSPEC int `hwloc_bitmap_isset` (`hwloc_const_bitmap_t` bitmap, unsigned id) `__hwloc_attribute_pure`
- HWLOC_DECLSPEC int `hwloc_bitmap_iszero` (`hwloc_const_bitmap_t` bitmap) `__hwloc_attribute_pure`
- HWLOC_DECLSPEC int `hwloc_bitmap_isfull` (`hwloc_const_bitmap_t` bitmap) `__hwloc_attribute_pure`
- HWLOC_DECLSPEC int `hwloc_bitmap_first` (`hwloc_const_bitmap_t` bitmap) `__hwloc_attribute_pure`
- HWLOC_DECLSPEC int `hwloc_bitmap_next` (`hwloc_const_bitmap_t` bitmap, int prev) `__hwloc_attribute_pure`
- HWLOC_DECLSPEC int `hwloc_bitmap_last` (`hwloc_const_bitmap_t` bitmap) `__hwloc_attribute_pure`
- HWLOC_DECLSPEC int `hwloc_bitmap_weight` (`hwloc_const_bitmap_t` bitmap) `__hwloc_attribute_pure`
- HWLOC_DECLSPEC void `hwloc_bitmap_or` (`hwloc_bitmap_t` res, `hwloc_const_bitmap_t` bitmap1, `hwloc_const_bitmap_t` bitmap2)
- HWLOC_DECLSPEC void `hwloc_bitmap_and` (`hwloc_bitmap_t` res, `hwloc_const_bitmap_t` bitmap1, `hwloc_const_bitmap_t` bitmap2)
- HWLOC_DECLSPEC void `hwloc_bitmap_andnot` (`hwloc_bitmap_t` res, `hwloc_const_bitmap_t` bitmap1, `hwloc_const_bitmap_t` bitmap2)
- HWLOC_DECLSPEC void `hwloc_bitmap_xor` (`hwloc_bitmap_t` res, `hwloc_const_bitmap_t` bitmap1, `hwloc_const_bitmap_t` bitmap2)
- HWLOC_DECLSPEC void `hwloc_bitmap_not` (`hwloc_bitmap_t` res, `hwloc_const_bitmap_t` bitmap)
- HWLOC_DECLSPEC int `hwloc_bitmap_intersects` (`hwloc_const_bitmap_t` bitmap1, `hwloc_const_bitmap_t` bitmap2) `__hwloc_attribute_pure`
- HWLOC_DECLSPEC int `hwloc_bitmap_isincluded` (`hwloc_const_bitmap_t` sub_bitmap, `hwloc_const_bitmap_t` super_bitmap) `__hwloc_attribute_pure`
- HWLOC_DECLSPEC int `hwloc_bitmap_isequal` (`hwloc_const_bitmap_t` bitmap1, `hwloc_const_bitmap_t` bitmap2) `__hwloc_attribute_pure`
- HWLOC_DECLSPEC int `hwloc_bitmap_compare_first` (`hwloc_const_bitmap_t` bitmap1, `hwloc_const_bitmap_t` bitmap2) `__hwloc_attribute_pure`
- HWLOC_DECLSPEC int `hwloc_bitmap_compare` (`hwloc_const_bitmap_t` bitmap1, `hwloc_const_bitmap_t` bitmap2) `__hwloc_attribute_pure`

14.27.1 Detailed Description

The `hwloc_bitmap_t` type represents a set of objects, typically OS processors – which may actually be hardware threads (represented by `hwloc_cpuset_t`, which is a typedef for `hwloc_bitmap_t`) – or memory nodes (represented by `hwloc_nodeset_t`, which is also a typedef for `hwloc_bitmap_t`).

Both CPU and node sets are always indexed by OS physical number.

Note

CPU sets and nodesets are described in [Object sets](#) (`hwloc_cpuset_t` and `hwloc_nodeset_t`).

A bitmap may be of infinite size.

14.27.2 Macro Definition Documentation

14.27.2.1 `#define hwloc_bitmap_foreach_begin(id, bitmap)`

Loop macro iterating on bitmap `bitmap`.

`index` is the loop variable; it should be an unsigned int. The first iteration will set `index` to the lowest index in the bitmap. Successive iterations will iterate through, in order, all remaining indexes that in the bitmap. To be specific: each iteration will return a value for `index` such that `hwloc_bitmap_isset(bitmap, index)` is true.

The assert prevents the loop from being infinite if the bitmap is infinite.

14.27.2.2 `#define hwloc_bitmap_foreach_end()`

Value:

```
} \  
} while (0)
```

14.27.3 Typedef Documentation

14.27.3.1 `typedef struct hwloc_bitmap_s* hwloc_bitmap_t`

Set of bits represented as an opaque pointer to an internal bitmap.

14.27.3.2 `typedef struct hwloc_bitmap_s* hwloc_const_bitmap_t`

a non-modifiable [hwloc_bitmap_t](#)

14.27.4 Function Documentation

14.27.4.1 `HWLOC_DECLSPEC void hwloc_bitmap_allbut (hwloc_bitmap_t bitmap, unsigned id)`

Fill the bitmap and clear the index `id`.

14.27.4.2 `HWLOC_DECLSPEC hwloc_bitmap_t hwloc_bitmap_alloc (void)`

Allocate a new empty bitmap.

Returns

A valid bitmap or `NULL`.

The bitmap should be freed by a corresponding call to [hwloc_bitmap_free\(\)](#).

14.27.4.3 `HWLOC_DECLSPEC hwloc_bitmap_t hwloc_bitmap_alloc_full (void)`

Allocate a new full bitmap.

14.27.4.4 `HWLOC_DECLSPEC void hwloc_bitmap_and (hwloc_bitmap_t res, hwloc_const_bitmap_t bitmap1, hwloc_const_bitmap_t bitmap2)`

And bitmaps `bitmap1` and `bitmap2` and store the result in bitmap `res`.

14.27.4.5 `HWLOC_DECLSPEC void hwloc_bitmap_andnot (hwloc_bitmap_t res, hwloc_const_bitmap_t bitmap1, hwloc_const_bitmap_t bitmap2)`

And bitmap `bitmap1` and the negation of `bitmap2` and store the result in bitmap `res`.

14.27.4.6 HWLOC_DECLSPEC int hwloc_bitmap_asprintf (char ** *strp*, hwloc_const_bitmap_t *bitmap*)

Stringify a bitmap into a newly allocated string.

14.27.4.7 HWLOC_DECLSPEC void hwloc_bitmap_clr (hwloc_bitmap_t *bitmap*, unsigned *id*)

Remove index *id* from bitmap *bitmap*.

14.27.4.8 HWLOC_DECLSPEC void hwloc_bitmap_clr_range (hwloc_bitmap_t *bitmap*, unsigned *begin*, int *end*)

Remove indexes from *begin* to *end* in bitmap *bitmap*.

If *end* is -1, the range is infinite.

14.27.4.9 HWLOC_DECLSPEC int hwloc_bitmap_compare (hwloc_const_bitmap_t *bitmap1*, hwloc_const_bitmap_t *bitmap2*)

Compare bitmaps *bitmap1* and *bitmap2* using their highest index.

Higher most significant bit is higher. The empty bitmap is considered lower than anything.

14.27.4.10 HWLOC_DECLSPEC int hwloc_bitmap_compare_first (hwloc_const_bitmap_t *bitmap1*, hwloc_const_bitmap_t *bitmap2*)

Compare bitmaps *bitmap1* and *bitmap2* using their lowest index.

Smaller least significant bit is smaller. The empty bitmap is considered higher than anything.

14.27.4.11 HWLOC_DECLSPEC void hwloc_bitmap_copy (hwloc_bitmap_t *dst*, hwloc_const_bitmap_t *src*)

Copy the contents of bitmap *src* into the already allocated bitmap *dst*.

14.27.4.12 HWLOC_DECLSPEC hwloc_bitmap_t hwloc_bitmap_dup (hwloc_const_bitmap_t *bitmap*)

Duplicate bitmap *bitmap* by allocating a new bitmap and copying *bitmap* contents.

If *bitmap* is NULL, NULL is returned.

14.27.4.13 HWLOC_DECLSPEC void hwloc_bitmap_fill (hwloc_bitmap_t *bitmap*)

Fill bitmap *bitmap* with all possible indexes (even if those objects don't exist or are otherwise unavailable)

14.27.4.14 HWLOC_DECLSPEC int hwloc_bitmap_first (hwloc_const_bitmap_t *bitmap*)

Compute the first index (least significant bit) in bitmap *bitmap*.

Returns

-1 if no index is set.

14.27.4.15 HWLOC_DECLSPEC void hwloc_bitmap_free (hwloc_bitmap_t *bitmap*)

Free bitmap *bitmap*.

If *bitmap* is NULL, no operation is performed.

14.27.4.16 HWLOC_DECLSPEC void hwloc_bitmap_from_ith_ulong (hwloc_bitmap_t *bitmap*, unsigned *i*, unsigned long *mask*)

Setup bitmap *bitmap* from unsigned long *mask* used as *i*-th subset.

14.27.4.17 HWLOC_DECLSPEC void hwloc_bitmap_from_ulong (hwloc_bitmap_t *bitmap*, unsigned long *mask*)

Setup bitmap *bitmap* from unsigned long *mask*.

14.27.4.18 HWLOC_DECLSPEC int hwloc_bitmap_intersects (hwloc_const_bitmap_t *bitmap1*, hwloc_const_bitmap_t *bitmap2*)

Test whether bitmaps *bitmap1* and *bitmap2* intersect.

14.27.4.19 HWLOC_DECLSPEC int hwloc_bitmap_isequal (hwloc_const_bitmap_t *bitmap1*, hwloc_const_bitmap_t *bitmap2*)

Test whether bitmap *bitmap1* is equal to bitmap *bitmap2*.

14.27.4.20 HWLOC_DECLSPEC int hwloc_bitmap_isfull (hwloc_const_bitmap_t *bitmap*)

Test whether bitmap *bitmap* is completely full.

14.27.4.21 HWLOC_DECLSPEC int hwloc_bitmap_isincluded (hwloc_const_bitmap_t *sub_bitmap*, hwloc_const_bitmap_t *super_bitmap*)

Test whether bitmap *sub_bitmap* is part of bitmap *super_bitmap*.

14.27.4.22 HWLOC_DECLSPEC int hwloc_bitmap_isset (hwloc_const_bitmap_t *bitmap*, unsigned *id*)

Test whether index *id* is part of bitmap *bitmap*.

14.27.4.23 HWLOC_DECLSPEC int hwloc_bitmap_iszero (hwloc_const_bitmap_t *bitmap*)

Test whether bitmap *bitmap* is empty.

14.27.4.24 HWLOC_DECLSPEC int hwloc_bitmap_last (hwloc_const_bitmap_t *bitmap*)

Compute the last index (most significant bit) in bitmap *bitmap*.

Returns

-1 if no index is bitmap, or if the index bitmap is infinite.

14.27.4.25 HWLOC_DECLSPEC int hwloc_bitmap_list_asprintf (char ** *strp*, hwloc_const_bitmap_t *bitmap*)

Stringify a bitmap into a newly allocated list string.

14.27.4.26 HWLOC_DECLSPEC int hwloc_bitmap_list_sprintf (char *_hwloc_restrict *buf*, size_t *buflen*, hwloc_const_bitmap_t *bitmap*)

Stringify a bitmap in the list format.

Lists are comma-separated indexes or ranges. Ranges are dash separated indexes. The last range may not have a ending indexes if the bitmap is infinite.

Up to *buflen* characters may be written in buffer *buf*.

If *buflen* is 0, *buf* may safely be NULL.

Returns

the number of character that were actually written if not truncating, or that would have been written (not including the ending `\0`).

14.27.4.27 HWLOC_DECLSPEC int hwloc_bitmap_list_sscanf (hwloc_bitmap_t *bitmap*, const char *_hwloc_restrict *string*)

Parse a list string and stores it in bitmap *bitmap*.

14.27.4.28 HWLOC_DECLSPEC int hwloc_bitmap_next (hwloc_const_bitmap_t *bitmap*, int *prev*)

Compute the next index in bitmap *bitmap* which is after index *prev*.

If *prev* is -1, the first index is returned.

Returns

-1 if no index with higher index is *bitmap*.

14.27.4.29 HWLOC_DECLSPEC void hwloc_bitmap_not (hwloc_bitmap_t *res*, hwloc_const_bitmap_t *bitmap*)

Negate bitmap *bitmap* and store the result in bitmap *res*.

14.27.4.30 HWLOC_DECLSPEC void hwloc_bitmap_only (hwloc_bitmap_t *bitmap*, unsigned *id*)

Empty the bitmap *bitmap* and add bit *id*.

14.27.4.31 HWLOC_DECLSPEC void hwloc_bitmap_or (hwloc_bitmap_t *res*, hwloc_const_bitmap_t *bitmap1*, hwloc_const_bitmap_t *bitmap2*)

Or bitmaps *bitmap1* and *bitmap2* and store the result in bitmap *res*.

14.27.4.32 HWLOC_DECLSPEC void hwloc_bitmap_set (hwloc_bitmap_t *bitmap*, unsigned *id*)

Add index *id* in bitmap *bitmap*.

14.27.4.33 **HWLOC_DECLSPEC** void `hwloc_bitmap_set_ith_ulong (hwloc_bitmap_t bitmap, unsigned i, unsigned long mask)`

Replace *i*-th subset of bitmap *bitmap* with unsigned long *mask*.

14.27.4.34 **HWLOC_DECLSPEC** void `hwloc_bitmap_set_range (hwloc_bitmap_t bitmap, unsigned begin, int end)`

Add indexes from *begin* to *end* in bitmap *bitmap*.

If *end* is `-1`, the range is infinite.

14.27.4.35 **HWLOC_DECLSPEC** void `hwloc_bitmap_singlify (hwloc_bitmap_t bitmap)`

Keep a single index among those set in bitmap *bitmap*.

May be useful before binding so that the process does not have a chance of migrating between multiple logical CPUs in the original mask.

14.27.4.36 **HWLOC_DECLSPEC** int `hwloc_bitmap_sprintf (char *__hwloc_restrict buf, size_t buflen, hwloc_const_bitmap_t bitmap)`

Stringify a bitmap.

Up to *buflen* characters may be written in buffer *buf*.

If *buflen* is 0, *buf* may safely be `NULL`.

Returns

the number of character that were actually written if not truncating, or that would have been written (not including the ending `\0`).

14.27.4.37 **HWLOC_DECLSPEC** int `hwloc_bitmap_sscanf (hwloc_bitmap_t bitmap, const char *__hwloc_restrict string)`

Parse a bitmap string and stores it in bitmap *bitmap*.

14.27.4.38 **HWLOC_DECLSPEC** int `hwloc_bitmap_taskset_asprintf (char ** strp, hwloc_const_bitmap_t bitmap)`

Stringify a bitmap into a newly allocated taskset-specific string.

14.27.4.39 **HWLOC_DECLSPEC** int `hwloc_bitmap_taskset_sprintf (char *__hwloc_restrict buf, size_t buflen, hwloc_const_bitmap_t bitmap)`

Stringify a bitmap in the taskset-specific format.

The taskset command manipulates bitmap strings that contain a single (possible very long) hexadecimal number starting with `0x`.

Up to *buflen* characters may be written in buffer *buf*.

If *buflen* is 0, *buf* may safely be `NULL`.

Returns

the number of character that were actually written if not truncating, or that would have been written (not including the ending `\0`).

14.27.4.40 `HWLOC_DECLSPEC int hwloc_bitmap_taskset_sscanf (hwloc_bitmap_t bitmap, const char *_hwloc_restrict string)`

Parse a taskset-specific bitmap string and stores it in bitmap `bitmap`.

14.27.4.41 `HWLOC_DECLSPEC unsigned long hwloc_bitmap_to_ith_ulong (hwloc_const_bitmap_t bitmap, unsigned i)`

Convert the `i`-th subset of bitmap `bitmap` into unsigned long mask.

14.27.4.42 `HWLOC_DECLSPEC unsigned long hwloc_bitmap_to_ulong (hwloc_const_bitmap_t bitmap)`

Convert the beginning part of bitmap `bitmap` into unsigned long mask.

14.27.4.43 `HWLOC_DECLSPEC int hwloc_bitmap_weight (hwloc_const_bitmap_t bitmap)`

Compute the "weight" of bitmap `bitmap` (i.e., number of indexes that are in the bitmap).

Returns

the number of indexes that are in the bitmap.

14.27.4.44 `HWLOC_DECLSPEC void hwloc_bitmap_xor (hwloc_bitmap_t res, hwloc_const_bitmap_t bitmap1, hwloc_const_bitmap_t bitmap2)`

Xor bitmaps `bitmap1` and `bitmap2` and store the result in bitmap `res`.

14.27.4.45 `HWLOC_DECLSPEC void hwloc_bitmap_zero (hwloc_bitmap_t bitmap)`

Empty the bitmap `bitmap`.

14.28 Helpers for manipulating glibc sched affinity

Functions

- static `__hwloc_inline int hwloc_cpuset_to_glibc_sched_affinity (hwloc_topology_t topology __hwloc_attribute_unused, hwloc_const_cpuset_t hwlocset, cpu_set_t *schedset, size_t schedsetsize)`
- static `__hwloc_inline int hwloc_cpuset_from_glibc_sched_affinity (hwloc_topology_t topology __hwloc_attribute_unused, hwloc_cpuset_t hwlocset, const cpu_set_t *schedset, size_t schedsetsize)`

14.28.1 Detailed Description

14.28.2 Function Documentation

14.28.2.1 `static __hwloc_inline int hwloc_cpuset_from_glibc_sched_affinity (hwloc_topology_t topology __hwloc_attribute_unused, hwloc_cpuset_t hwlocset, const cpu_set_t * schedset, size_t schedsetsize) [static]`

Convert glibc sched affinity CPU set `schedset` into hwloc CPU set.

This function may be used before calling `sched_setaffinity` or any other function that takes a `cpu_set_t` as input parameter.

`schedsetsize` should be `sizeof(cpu_set_t)` unless `schedset` was dynamically allocated with `CPU_ALLOC`

14.28.2.2 `static __hwloc_inline int hwloc_cpuset_to_glibc_sched_affinity (hwloc_topology_t topology __hwloc_attribute_unused, hwloc_const_cpuset_t hwlocset, cpu_set_t * schedset, size_t schedsetsize) [static]`

Convert hwloc CPU set `toposet` into glibc sched affinity CPU set `schedset`.

This function may be used before calling `sched_setaffinity` or any other function that takes a `cpu_set_t` as input parameter.

`schedsetsize` should be `sizeof(cpu_set_t)` unless `schedset` was dynamically allocated with `CPU_ALLOC`

14.29 Linux-only helpers

Functions

- HWLOC_DECLSPEC int `hwloc_linux_parse_cpumap_file` (FILE *file, `hwloc_cpuset_t` set)
- HWLOC_DECLSPEC int `hwloc_linux_set_tid_cpupubind` (`hwloc_topology_t` topology, pid_t tid, `hwloc_const_cpuset_t` set)
- HWLOC_DECLSPEC int `hwloc_linux_get_tid_cpupubind` (`hwloc_topology_t` topology, pid_t tid, `hwloc_cpuset_t` set)

14.29.1 Detailed Description

This includes helpers for manipulating linux kernel cpumap files, and hwloc equivalents of the Linux `sched_setaffinity` and `sched_getaffinity` system calls.

14.29.2 Function Documentation

14.29.2.1 HWLOC_DECLSPEC int `hwloc_linux_get_tid_cpupubind` (`hwloc_topology_t` topology, pid_t tid, `hwloc_cpuset_t` set)

Get the current binding of thread `tid`.

The behavior is exactly the same as the Linux `sched_getaffinity` system call, but uses a hwloc cpuset.

14.29.2.2 HWLOC_DECLSPEC int `hwloc_linux_parse_cpumap_file` (FILE * file, `hwloc_cpuset_t` set)

Convert a linux kernel cpumap file `file` into hwloc CPU set.

Might be used when reading CPU set from sysfs attributes such as topology and caches for processors, or `local_cpus` for devices.

14.29.2.3 HWLOC_DECLSPEC int `hwloc_linux_set_tid_cpupubind` (`hwloc_topology_t` topology, pid_t tid, `hwloc_const_cpuset_t` set)

Bind a thread `tid` on cpus given in cpuset `set`.

The behavior is exactly the same as the Linux `sched_setaffinity` system call, but uses a hwloc cpuset.

14.30 Helpers for manipulating Linux libnuma unsigned long masks

Functions

- static `__hwloc_inline int hwloc_cpuset_to_linux_libnuma_ulongs (hwloc_topology_t topology, hwloc_const_cpuset_t cpuset, unsigned long *mask, unsigned long *maxnode)`
- static `__hwloc_inline int hwloc_nodeset_to_linux_libnuma_ulongs (hwloc_topology_t topology, hwloc_const_nodeset_t nodeset, unsigned long *mask, unsigned long *maxnode)`
- static `__hwloc_inline int hwloc_cpuset_from_linux_libnuma_ulongs (hwloc_topology_t topology, hwloc_cpuset_t cpuset, const unsigned long *mask, unsigned long maxnode)`
- static `__hwloc_inline int hwloc_nodeset_from_linux_libnuma_ulongs (hwloc_topology_t topology, hwloc_nodeset_t nodeset, const unsigned long *mask, unsigned long maxnode)`

14.30.1 Detailed Description

14.30.2 Function Documentation

14.30.2.1 static `__hwloc_inline int hwloc_cpuset_from_linux_libnuma_ulongs (hwloc_topology_t topology, hwloc_cpuset_t cpuset, const unsigned long * mask, unsigned long maxnode)` [static]

Convert the array of unsigned long `mask` into hwloc CPU set.

`mask` is a array of unsigned long that will be read. `maxnode` contains the maximal node number that may be read in `mask`.

This function may be used after calling `get_mempolicy` or any other function that takes an array of unsigned long as output parameter (and possibly a maximal node number as input parameter).

14.30.2.2 static `__hwloc_inline int hwloc_cpuset_to_linux_libnuma_ulongs (hwloc_topology_t topology, hwloc_const_cpuset_t cpuset, unsigned long * mask, unsigned long * maxnode)` [static]

Convert hwloc CPU set `cpuset` into the array of unsigned long `mask`.

`mask` is the array of unsigned long that will be filled. `maxnode` contains the maximal node number that may be stored in `mask`. `maxnode` will be set to the maximal node number that was found, plus one.

This function may be used before calling `set_mempolicy`, `mbind`, `migrate_pages` or any other function that takes an array of unsigned long and a maximal node number as input parameter.

14.30.2.3 static `__hwloc_inline int hwloc_nodeset_from_linux_libnuma_ulongs (hwloc_topology_t topology, hwloc_nodeset_t nodeset, const unsigned long * mask, unsigned long maxnode)` [static]

Convert the array of unsigned long `mask` into hwloc NUMA node set.

`mask` is a array of unsigned long that will be read. `maxnode` contains the maximal node number that may be read in `mask`.

This function may be used after calling `get_mempolicy` or any other function that takes an array of unsigned long as output parameter (and possibly a maximal node number as input parameter).

```
14.30.2.4 static __hwloc_inline int hwloc_nodeseq_to_linux_libnuma_ulongs ( hwloc_topology_t topology,  
    hwloc_const_nodeseq_t nodeseq, unsigned long * mask, unsigned long * maxnode ) [static]
```

Convert hwloc NUMA node set `nodeseq` into the array of unsigned long `mask`.

`mask` is the array of unsigned long that will be filled. `maxnode` contains the maximal node number that may be stored in `mask`. `maxnode` will be set to the maximal node number that was found, plus one.

This function may be used before calling `set_mempolicy`, `mbind`, `migrate_pages` or any other function that takes an array of unsigned long and a maximal node number as input parameter.

14.31 Helpers for manipulating Linux libnuma bitmask

Functions

- static `__hwloc_inline struct bitmask * hwloc_cpuset_to_linux_libnuma_bitmask (hwloc_topology_t topology, hwloc_const_cpuset_t cpuset) __hwloc_attribute_malloc`
- static `__hwloc_inline struct bitmask * hwloc_nodeseq_to_linux_libnuma_bitmask (hwloc_topology_t topology, hwloc_const_nodeseq_t nodeset) __hwloc_attribute_malloc`
- static `__hwloc_inline int hwloc_cpuset_from_linux_libnuma_bitmask (hwloc_topology_t topology, hwloc_cpuset_t cpuset, const struct bitmask *bitmask)`
- static `__hwloc_inline int hwloc_nodeseq_from_linux_libnuma_bitmask (hwloc_topology_t topology, hwloc_nodeseq_t nodeset, const struct bitmask *bitmask)`

14.31.1 Detailed Description

14.31.2 Function Documentation

14.31.2.1 `static __hwloc_inline int hwloc_cpuset_from_linux_libnuma_bitmask (hwloc_topology_t topology, hwloc_cpuset_t cpuset, const struct bitmask * bitmask) [static]`

Convert libnuma bitmask `bitmask` into hwloc CPU set `cpuset`.

This function may be used after calling many `numa_` functions that use a struct bitmask as an output parameter.

14.31.2.2 `static __hwloc_inline struct bitmask * hwloc_cpuset_to_linux_libnuma_bitmask (hwloc_topology_t topology, hwloc_const_cpuset_t cpuset) [static], [read]`

Convert hwloc CPU set `cpuset` into the returned libnuma bitmask.

The returned bitmask should later be freed with `numa_bitmask_free`.

This function may be used before calling many `numa_` functions that use a struct bitmask as an input parameter.

Returns

newly allocated struct bitmask.

14.31.2.3 `static __hwloc_inline int hwloc_nodeseq_from_linux_libnuma_bitmask (hwloc_topology_t topology, hwloc_nodeseq_t nodeset, const struct bitmask * bitmask) [static]`

Convert libnuma bitmask `bitmask` into hwloc NUMA node set `nodeset`.

This function may be used after calling many `numa_` functions that use a struct bitmask as an output parameter.

14.31.2.4 `static __hwloc_inline struct bitmask * hwloc_nodeseq_to_linux_libnuma_bitmask (hwloc_topology_t topology, hwloc_const_nodeseq_t nodeset) [static], [read]`

Convert hwloc NUMA node set `nodeset` into the returned libnuma bitmask.

The returned bitmask should later be freed with `numa_bitmask_free`.

This function may be used before calling many `numa_` functions that use a struct bitmask as an input parameter.

Returns

newly allocated struct bitmask.

14.32 Helpers for manipulating Linux libnuma nodemask_t

Functions

- static `__hwloc_inline int hwloc_cpuset_to_linux_libnuma_nodemask (hwloc_topology_t topology, hwloc_const_cpuset_t cpuset, nodemask_t *nodemask)`
- static `__hwloc_inline int hwloc_nodeseq_to_linux_libnuma_nodemask (hwloc_topology_t topology, hwloc_const_nodeseq_t nodeset, nodemask_t *nodemask)`
- static `__hwloc_inline int hwloc_cpuset_from_linux_libnuma_nodemask (hwloc_topology_t topology, hwloc_cpuset_t cpuset, const nodemask_t *nodemask)`
- static `__hwloc_inline int hwloc_nodeseq_from_linux_libnuma_nodemask (hwloc_topology_t topology, hwloc_nodeseq_t nodeset, const nodemask_t *nodemask)`

14.32.1 Detailed Description

Note

The Linux libnuma `nodemask_t` interface is deprecated and its implementation is at least incorrect with respect to sparse NUMA node ids. It is strongly advised to use struct `bitmask` instead of `nodemask_t`, or even to use `hwloc` directly.

14.32.2 Function Documentation

14.32.2.1 `static __hwloc_inline int hwloc_cpuset_from_linux_libnuma_nodemask (hwloc_topology_t topology, hwloc_cpuset_t cpuset, const nodemask_t * nodemask) [static]`

Convert libnuma `nodemask` `nodemask` into `hwloc` CPU set `cpuset`.

This function may be used before calling some old libnuma functions that use a `nodemask_t` as an output parameter.

14.32.2.2 `static __hwloc_inline int hwloc_cpuset_to_linux_libnuma_nodemask (hwloc_topology_t topology, hwloc_const_cpuset_t cpuset, nodemask_t * nodemask) [static]`

Convert `hwloc` CPU set `cpuset` into libnuma `nodemask` `nodemask`.

This function may be used before calling some old libnuma functions that use a `nodemask_t` as an input parameter.

14.32.2.3 `static __hwloc_inline int hwloc_nodeseq_from_linux_libnuma_nodemask (hwloc_topology_t topology, hwloc_nodeseq_t nodeset, const nodemask_t * nodemask) [static]`

Convert libnuma `nodemask` `nodemask` into `hwloc` NUMA node set `nodeset`.

This function may be used before calling some old libnuma functions that use a `nodemask_t` as an output parameter.

14.32.2.4 `static __hwloc_inline int hwloc_nodeseq_to_linux_libnuma_nodemask (hwloc_topology_t topology, hwloc_const_nodeseq_t nodeset, nodemask_t * nodemask) [static]`

Convert `hwloc` NUMA node set `nodeset` into libnuma `nodemask` `nodemask`.

This function may be used before calling some old libnuma functions that use a `nodemask_t` as an input parameter.

14.33 CUDA Driver API Specific Functions

Functions

- static `__hwloc_inline` int `hwloc_cuda_get_device_cpuset` (`hwloc_topology_t` topology `__hwloc_attribute_unused`, CUdevice `cudevice`, `hwloc_cpuset_t` set)

14.33.1 Detailed Description

14.33.2 Function Documentation

14.33.2.1 static `__hwloc_inline` int `hwloc_cuda_get_device_cpuset` (`hwloc_topology_t` topology `__hwloc_attribute_unused`, CUdevice `cudevice`, `hwloc_cpuset_t` set) [static]

Get the CPU set of logical processors that are physically close to device `cudevice`.

For the given CUDA Driver API device `cudevice`, read the corresponding kernel-provided `cpumap` file and return the corresponding CPU set. This function is currently only implemented in a meaningful way for Linux; other systems will simply get a full `cpuset`.

14.34 CUDA Runtime API Specific Functions

Functions

- static `__hwloc_inline int hwloc_cudart_get_device_cpuset (hwloc_topology_t topology __hwloc_attribute_unused, int device, hwloc_cpuset_t set)`

14.34.1 Detailed Description

14.34.2 Function Documentation

14.34.2.1 `static __hwloc_inline int hwloc_cudart_get_device_cpuset (hwloc_topology_t topology __hwloc_attribute_unused, int device, hwloc_cpuset_t set) [static]`

Get the CPU set of logical processors that are physically close to device `cudevice`.

For the given CUDA Runtime API device `cudevice`, read the corresponding kernel-provided `cpumap` file and return the corresponding CPU set. This function is currently only implemented in a meaningful way for Linux; other systems will simply get a full `cpuset`.

14.35 OpenFabrics-Specific Functions

Functions

- static __hwloc_inline int `hwloc_ibv_get_device_cpuset` (`hwloc_topology_t` topology, __hwloc_attribute_unused, struct `ibv_device` *`ibdev`, `hwloc_cpuset_t` set)

14.35.1 Detailed Description

14.35.2 Function Documentation

14.35.2.1 static __hwloc_inline int `hwloc_ibv_get_device_cpuset` (`hwloc_topology_t` topology, __*hwloc_attribute_unused*, struct `ibv_device` * *ibdev*, `hwloc_cpuset_t` set) [static]

Get the CPU set of logical processors that are physically close to device `ibdev`.

For the given OpenFabrics device `ibdev`, read the corresponding kernel-provided cpumap file and return the corresponding CPU set. This function is currently only implemented in a meaningful way for Linux; other systems will simply get a full cpuset.

14.36 Myrinet Express-Specific Functions

Functions

- static `__hwloc_inline int hwloc_mx_board_get_device_cpuset (hwloc_topology_t topology, unsigned id, hwloc_cpuset_t set)`
- static `__hwloc_inline int hwloc_mx_endpoint_get_device_cpuset (hwloc_topology_t topology, mx_endpoint_t endpoint, hwloc_cpuset_t set)`

14.36.1 Detailed Description

14.36.2 Function Documentation

14.36.2.1 `static __hwloc_inline int hwloc_mx_board_get_device_cpuset (hwloc_topology_t topology, unsigned id, hwloc_cpuset_t set) [static]`

Get the CPU set of logical processors that are physically close the MX board `id`.

For the given Myrinet Express board index `id`, read the OS-provided NUMA node and return the corresponding CPU set.

14.36.2.2 `static __hwloc_inline int hwloc_mx_endpoint_get_device_cpuset (hwloc_topology_t topology, mx_endpoint_t endpoint, hwloc_cpuset_t set) [static]`

Get the CPU set of logical processors that are physically close to endpoint `endpoint`.

For the given Myrinet Express endpoint `endpoint`, read the OS-provided NUMA node and return the corresponding CPU set.

Chapter 15

Data Structure Documentation

15.1 hwloc_obj_attr_u::hwloc_bridge_attr_s Struct Reference

```
#include <hwloc.h>
```

Data Fields

- union {
 - struct [hwloc_pcidev_attr_s](#) pci } upstream
- [hwloc_obj_bridge_type_t](#) upstream_type
- union {
 - struct {
 - unsigned short [domain](#)
 - unsigned char [secondary_bus](#)
 - unsigned char [subordinate_bus](#) } pci } downstream
- [hwloc_obj_bridge_type_t](#) downstream_type
- unsigned [depth](#)

15.1.1 Detailed Description

Bridge specific Object Attributes.

15.1.2 Field Documentation

15.1.2.1 unsigned [hwloc_obj_attr_u::hwloc_bridge_attr_s::depth](#)

15.1.2.2 unsigned short [hwloc_obj_attr_u::hwloc_bridge_attr_s::domain](#)

15.1.2.3 union { ... } [hwloc_obj_attr_u::hwloc_bridge_attr_s::downstream](#)

15.1.2.4 `hwloc_obj_bridge_type_t hwloc_obj_attr_u::hwloc_bridge_attr_s::downstream_type`

15.1.2.5 `struct hwloc_pcidev_attr_s hwloc_obj_attr_u::hwloc_bridge_attr_s::pci`

15.1.2.6 `struct { ... } hwloc_obj_attr_u::hwloc_bridge_attr_s::pci`

15.1.2.7 `unsigned char hwloc_obj_attr_u::hwloc_bridge_attr_s::secondary_bus`

15.1.2.8 `unsigned char hwloc_obj_attr_u::hwloc_bridge_attr_s::subordinate_bus`

15.1.2.9 `union { ... } hwloc_obj_attr_u::hwloc_bridge_attr_s::upstream`

15.1.2.10 `hwloc_obj_bridge_type_t hwloc_obj_attr_u::hwloc_bridge_attr_s::upstream_type`

The documentation for this struct was generated from the following file:

- `hwloc.h`

15.2 `hwloc_obj_attr_u::hwloc_cache_attr_s` Struct Reference

```
#include <hwloc.h>
```

Data Fields

- `hwloc_uint64_t size`
- unsigned `depth`
- unsigned `linesize`
- int `associativity`

15.2.1 Detailed Description

Cache-specific Object Attributes.

15.2.2 Field Documentation

15.2.2.1 `int hwloc_obj_attr_u::hwloc_cache_attr_s::associativity`

Ways of associativity, -1 if fully associative, 0 if unknown.

15.2.2.2 `unsigned hwloc_obj_attr_u::hwloc_cache_attr_s::depth`

Depth of cache (e.g., L1, L2, ...etc.)

15.2.2.3 `unsigned hwloc_obj_attr_u::hwloc_cache_attr_s::linesize`

Cache-line size in bytes.

15.2.2.4 hwloc_uint64_t hwloc_obj_attr_u::hwloc_cache_attr_s::size

Size of cache in bytes.

The documentation for this struct was generated from the following file:

- hwloc.h

15.3 hwloc_distances_s Struct Reference

```
#include <hwloc.h>
```

Data Fields

- unsigned [relative_depth](#)
- unsigned [nbobjs](#)
- float * [latency](#)
- float [latency_max](#)
- float [latency_base](#)

15.3.1 Detailed Description

Distances between objects.

One object may contain a distance structure describing distances between all its descendants at a given relative depth. If the containing object is the root object of the topology, then the distances are available for all objects in the machine.

If the `latency` pointer is not `NULL`, the pointed array contains memory latencies (non-zero values), as defined by the ACPI SLIT specification.

In the future, some other types of distances may be considered. In these cases, `latency` may be `NULL`.

15.3.2 Field Documentation

15.3.2.1 float* hwloc_distances_s::latency

Matrix of latencies between objects, stored as a one-dimension array. May be `NULL` if the distances considered here are not latencies. Values are normalized to get 1.0 as the minimal value in the matrix. Latency from *i*-th to *j*-th object is stored in slot `i*nbobjs+j`.

15.3.2.2 float hwloc_distances_s::latency_base

The multiplier that should be applied to latency matrix to retrieve the original OS-provided latencies. Usually 10 on Linux since ACPI SLIT uses 10 for local latency.

15.3.2.3 float hwloc_distances_s::latency_max

The maximal value in the latency matrix.

15.3.2.4 unsigned hwloc_distances_s::nbobjs

Number of objects considered in the matrix. It is the number of descendant objects at `relative_depth` below the containing object. It corresponds to the result of `hwloc_get_nbobjs_inside_cpuset_by_depth`.

15.3.2.5 unsigned hwloc_distances_s::relative_depth

Relative depth of the considered objects below the object containing this distance information.

The documentation for this struct was generated from the following file:

- `hwloc.h`

15.4 hwloc_obj_attr_u::hwloc_group_attr_s Struct Reference

```
#include <hwloc.h>
```

Data Fields

- unsigned [depth](#)

15.4.1 Detailed Description

Group-specific Object Attributes.

15.4.2 Field Documentation

15.4.2.1 unsigned hwloc_obj_attr_u::hwloc_group_attr_s::depth

Depth of group object.

The documentation for this struct was generated from the following file:

- `hwloc.h`

15.5 hwloc_obj Struct Reference

```
#include <hwloc.h>
```

Data Fields

- [hwloc_obj_type_t](#) type
- unsigned [os_index](#)
- `char * name`
- struct [hwloc_obj_memory_s](#) memory
- union [hwloc_obj_attr_u](#) * attr
- unsigned [depth](#)

- unsigned [logical_index](#)
- signed [os_level](#)
- struct [hwloc_obj](#) * [next_cousin](#)
- struct [hwloc_obj](#) * [prev_cousin](#)
- struct [hwloc_obj](#) * [parent](#)
- unsigned [sibling_rank](#)
- struct [hwloc_obj](#) * [next_sibling](#)
- struct [hwloc_obj](#) * [prev_sibling](#)
- unsigned [arity](#)
- struct [hwloc_obj](#) ** [children](#)
- struct [hwloc_obj](#) * [first_child](#)
- struct [hwloc_obj](#) * [last_child](#)
- void * [userdata](#)
- [hwloc_cpuset_t](#) [cpuset](#)
- [hwloc_cpuset_t](#) [complete_cpuset](#)
- [hwloc_cpuset_t](#) [online_cpuset](#)
- [hwloc_cpuset_t](#) [allowed_cpuset](#)
- [hwloc_nodest_t](#) [nodeset](#)
- [hwloc_nodest_t](#) [complete_nodeset](#)
- [hwloc_nodest_t](#) [allowed_nodeset](#)
- struct [hwloc_distances_s](#) ** [distances](#)
- unsigned [distances_count](#)
- struct [hwloc_obj_info_s](#) * [infos](#)
- unsigned [infos_count](#)

15.5.1 Detailed Description

Structure of a topology object.

Applications must not modify any field except [hwloc_obj.userdata](#).

15.5.2 Field Documentation

15.5.2.1 [hwloc_cpuset_t](#) [hwloc_obj::allowed_cpuset](#)

The CPU set of allowed logical processors.

This includes the CPUs contained in this object which are allowed for binding, i.e. passing them to the hwloc binding functions should not return permission errors. This is usually restricted by administration rules. Some of them may however be offline so binding to them may still not be possible, see [online_cpuset](#).

Note

Its value must not be changed, [hwloc_bitmap_dup](#) must be used instead.

15.5.2.2 `hwloc_nodese_t hwloc_obj::allowed_nodese`

The set of allowed NUMA memory nodes.

This includes the NUMA memory nodes contained in this object which are allowed for memory allocation, i.e. passing them to NUMA node-directed memory allocation should not return permission errors. This is usually restricted by administration rules.

If there are no NUMA nodes in the machine, all the memory is close to this object, so `allowed_nodese` is full.

Note

Its value must not be changed, `hwloc_bitmap_dup` must be used instead.

15.5.2.3 `unsigned hwloc_obj::arity`

Number of children.

15.5.2.4 `union hwloc_obj_attr_u* hwloc_obj::attr`

Object type-specific Attributes, may be `NULL` if no attribute value was found.

15.5.2.5 `struct hwloc_obj** hwloc_obj::children`

Children, `children[0 .. arity -1]`.

15.5.2.6 `hwloc_cpuset_t hwloc_obj::complete_cpuset`

The complete CPU set of logical processors of this object,.

This includes not only the same as the `cpuset` field, but also the CPUs for which topology information is unknown or incomplete, and the CPUs that are ignored when the `HWLOC_TOPOLOGY_FLAG_WHOLE_SYSTEM` flag is not set. Thus no corresponding PU object may be found in the topology, because the precise position is undefined. It is however known that it would be somewhere under this object.

Note

Its value must not be changed, `hwloc_bitmap_dup` must be used instead.

15.5.2.7 `hwloc_nodese_t hwloc_obj::complete_nodese`

The complete NUMA node set of this object,.

This includes not only the same as the `nodese` field, but also the NUMA nodes for which topology information is unknown or incomplete, and the nodes that are ignored when the `HWLOC_TOPOLOGY_FLAG_WHOLE_SYSTEM` flag is not set. Thus no corresponding `NODE` object may be found in the topology, because the precise position is undefined. It is however known that it would be somewhere under this object.

If there are no NUMA nodes in the machine, all the memory is close to this object, so `complete_nodese` is full.

Note

Its value must not be changed, `hwloc_bitmap_dup` must be used instead.

15.5.2.8 hwloc_cpuset_t hwloc_obj::cpuset

CPUs covered by this object.

This is the set of CPUs for which there are PU objects in the topology under this object, i.e. which are known to be physically contained in this object and known how (the children path between this object and the PU objects).

If the HWLOC_TOPOLOGY_FLAG_WHOLE_SYSTEM configuration flag is set, some of these CPUs may be offline, or not allowed for binding, see `online_cpuset` and `allowed_cpuset`.

Note

Its value must not be changed, `hwloc_bitmap_dup` must be used instead.

15.5.2.9 unsigned hwloc_obj::depth

Vertical index in the hierarchy.

15.5.2.10 struct hwloc_distances_s** hwloc_obj::distances

Distances between all objects at same depth below this object.

15.5.2.11 unsigned hwloc_obj::distances_count

15.5.2.12 struct hwloc_obj* hwloc_obj::first_child

First child.

15.5.2.13 struct hwloc_obj_info_s* hwloc_obj::infos

Array of stringified info type=name.

15.5.2.14 unsigned hwloc_obj::infos_count

Size of infos array.

15.5.2.15 struct hwloc_obj* hwloc_obj::last_child

Last child.

15.5.2.16 unsigned hwloc_obj::logical_index

Horizontal index in the whole list of similar objects, could be a "cousin_rank" since it's the rank within the "cousin" list below.

15.5.2.17 struct hwloc_obj_memory_s hwloc_obj::memory

Memory attributes.

15.5.2.18 `char* hwloc_obj::name`

Object description if any.

15.5.2.19 `struct hwloc_obj* hwloc_obj::next_cousin`

Next object of same type and depth.

15.5.2.20 `struct hwloc_obj* hwloc_obj::next_sibling`

Next object below the same parent.

15.5.2.21 `hwloc_noderset_t hwloc_obj::nodeset`

NUMA nodes covered by this object or containing this object.

This is the set of NUMA nodes for which there are NODE objects in the topology under or above this object, i.e. which are known to be physically contained in this object or containing it and known how (the children path between this object and the NODE objects).

In the end, these nodes are those that are close to the current object.

If the `HWLOC_TOPOLOGY_FLAG_WHOLE_SYSTEM` configuration flag is set, some of these nodes may not be allowed for allocation, see `allowed_nodeset`.

If there are no NUMA nodes in the machine, all the memory is close to this object, so `nodeset` is full.

Note

Its value must not be changed, `hwloc_bitmap_dup` must be used instead.

15.5.2.22 `hwloc_cpuset_t hwloc_obj::online_cpuset`

The CPU set of online logical processors.

This includes the CPUs contained in this object that are online, i.e. draw power and can execute threads. It may however not be allowed to bind to them due to administration rules, see `allowed_cpuset`.

Note

Its value must not be changed, `hwloc_bitmap_dup` must be used instead.

15.5.2.23 `unsigned hwloc_obj::os_index`

OS-provided physical index number.

15.5.2.24 `signed hwloc_obj::os_level`

OS-provided physical level, -1 if unknown or meaningless.

15.5.2.25 struct hwloc_obj* hwloc_obj::parent

Parent, NULL if root (system object)

15.5.2.26 struct hwloc_obj* hwloc_obj::prev_cousin

Previous object of same type and depth.

15.5.2.27 struct hwloc_obj* hwloc_obj::prev_sibling

Previous object below the same parent.

15.5.2.28 unsigned hwloc_obj::sibling_rank

Index in parent's children[] array.

15.5.2.29 hwloc_obj_type_t hwloc_obj::type

Type of object.

15.5.2.30 void* hwloc_obj::userdata

Application-given private data pointer, initialized to NULL, use it as you wish.

The documentation for this struct was generated from the following file:

- hwloc.h

15.6 hwloc_obj_attr_u Union Reference

```
#include <hwloc.h>
```

Data Structures

- struct [hwloc_bridge_attr_s](#)
- struct [hwloc_cache_attr_s](#)
- struct [hwloc_group_attr_s](#)
- struct [hwloc_osdev_attr_s](#)
- struct [hwloc_pcidev_attr_s](#)

Data Fields

- struct [hwloc_obj_attr_u::hwloc_cache_attr_s](#) cache
- struct [hwloc_obj_attr_u::hwloc_group_attr_s](#) group

- struct [hwloc_obj_attr_u::hwloc_pcidev_attr_s](#) pcidev
- struct [hwloc_obj_attr_u::hwloc_bridge_attr_s](#) bridge
- struct [hwloc_obj_attr_u::hwloc_osdev_attr_s](#) osdev

15.6.1 Detailed Description

Object type-specific Attributes.

15.6.2 Field Documentation

15.6.2.1 struct [hwloc_obj_attr_u::hwloc_bridge_attr_s](#) hwloc_obj_attr_u::bridge

15.6.2.2 struct [hwloc_obj_attr_u::hwloc_cache_attr_s](#) hwloc_obj_attr_u::cache

15.6.2.3 struct [hwloc_obj_attr_u::hwloc_group_attr_s](#) hwloc_obj_attr_u::group

15.6.2.4 struct [hwloc_obj_attr_u::hwloc_osdev_attr_s](#) hwloc_obj_attr_u::osdev

15.6.2.5 struct [hwloc_obj_attr_u::hwloc_pcidev_attr_s](#) hwloc_obj_attr_u::pcidev

The documentation for this union was generated from the following file:

- [hwloc.h](#)

15.7 hwloc_obj_info_s Struct Reference

```
#include <hwloc.h>
```

Data Fields

- char * [name](#)
- char * [value](#)

15.7.1 Detailed Description

Object info.

15.7.2 Field Documentation

15.7.2.1 char* [hwloc_obj_info_s::name](#)

Info name.

15.7.2.2 char* hwloc_obj_info_s::value

Info value.

The documentation for this struct was generated from the following file:

- hwloc.h

15.8 hwloc_obj_memory_s::hwloc_obj_memory_page_type_s Struct Reference

```
#include <hwloc.h>
```

Data Fields

- hwloc_uint64_t [size](#)
- hwloc_uint64_t [count](#)

15.8.1 Detailed Description

Array of local memory page types, NULL if no local memory and `page_types` is 0.

The array is sorted by increasing `size` fields. It contains `page_types_len` slots.

15.8.2 Field Documentation

15.8.2.1 hwloc_uint64_t hwloc_obj_memory_s::hwloc_obj_memory_page_type_s::count

Number of pages of this size.

15.8.2.2 hwloc_uint64_t hwloc_obj_memory_s::hwloc_obj_memory_page_type_s::size

Size of pages.

The documentation for this struct was generated from the following file:

- hwloc.h

15.9 hwloc_obj_memory_s Struct Reference

```
#include <hwloc.h>
```

Data Structures

- struct [hwloc_obj_memory_page_type_s](#)

Data Fields

- hwloc_uint64_t [total_memory](#)
- hwloc_uint64_t [local_memory](#)
- unsigned [page_types_len](#)
- struct [hwloc_obj_memory_s::hwloc_obj_memory_page_type_s * page_types](#)

15.9.1 Detailed Description

Object memory.

15.9.2 Field Documentation

15.9.2.1 hwloc_uint64_t hwloc_obj_memory_s::local_memory

Local memory (in bytes)

15.9.2.2 struct hwloc_obj_memory_s::hwloc_obj_memory_page_type_s * hwloc_obj_memory_s::page_types

15.9.2.3 unsigned hwloc_obj_memory_s::page_types_len

Size of array `page_types`.

15.9.2.4 hwloc_uint64_t hwloc_obj_memory_s::total_memory

Total memory (in bytes) in this object and its children.

The documentation for this struct was generated from the following file:

- `hwloc.h`

15.10 hwloc_obj_attr_u::hwloc_osdev_attr_s Struct Reference

```
#include <hwloc.h>
```

Data Fields

- [hwloc_obj_osdev_type_t](#) type

15.10.1 Detailed Description

OS Device specific Object Attributes.

15.10.2 Field Documentation

15.10.2.1 hwloc_obj_osdev_type_t hwloc_obj_attr_u::hwloc_osdev_attr_s::type

The documentation for this struct was generated from the following file:

- hwloc.h

15.11 hwloc_obj_attr_u::hwloc_pcidev_attr_s Struct Reference

```
#include <hwloc.h>
```

Data Fields

- unsigned short [domain](#)
- unsigned char [bus](#)
- unsigned char [dev](#)
- unsigned char [func](#)
- unsigned short [class_id](#)
- unsigned short [vendor_id](#)
- unsigned short [device_id](#)
- unsigned short [subvendor_id](#)
- unsigned short [subdevice_id](#)
- unsigned char [revision](#)
- float [linkspeed](#)

15.11.1 Detailed Description

PCI Device specific Object Attributes.

15.11.2 Field Documentation

15.11.2.1 unsigned char hwloc_obj_attr_u::hwloc_pcidev_attr_s::bus

15.11.2.2 unsigned short hwloc_obj_attr_u::hwloc_pcidev_attr_s::class_id

15.11.2.3 unsigned char hwloc_obj_attr_u::hwloc_pcidev_attr_s::dev

15.11.2.4 unsigned short hwloc_obj_attr_u::hwloc_pcidev_attr_s::device_id

15.11.2.5 unsigned short hwloc_obj_attr_u::hwloc_pcidev_attr_s::domain

15.11.2.6 unsigned char hwloc_obj_attr_u::hwloc_pcidev_attr_s::func

15.11.2.7 float hwloc_obj_attr_u::hwloc_pcidev_attr_s::linkspeed

15.11.2.8 unsigned char hwloc_obj_attr_u::hwloc_pcidev_attr_s::revision

15.11.2.9 unsigned short hwloc_obj_attr_u::hwloc_pcidev_attr_s::subdevice_id

15.11.2.10 unsigned short hwloc_obj_attr_u::hwloc_pcidev_attr_s::subvendor_id

15.11.2.11 unsigned short hwloc_obj_attr_u::hwloc_pcidev_attr_s::vendor_id

The documentation for this struct was generated from the following file:

- hwloc.h

15.12 hwloc_topology_cpupbind_support Struct Reference

```
#include <hwloc.h>
```

Data Fields

- unsigned char [set_thisproc_cpupbind](#)
- unsigned char [get_thisproc_cpupbind](#)
- unsigned char [set_proc_cpupbind](#)
- unsigned char [get_proc_cpupbind](#)
- unsigned char [set_thisthread_cpupbind](#)
- unsigned char [get_thisthread_cpupbind](#)
- unsigned char [set_thread_cpupbind](#)
- unsigned char [get_thread_cpupbind](#)
- unsigned char [get_thisproc_last_cpu_location](#)
- unsigned char [get_proc_last_cpu_location](#)
- unsigned char [get_thisthread_last_cpu_location](#)

15.12.1 Detailed Description

Flags describing actual PU binding support for this topology.

15.12.2 Field Documentation

15.12.2.1 unsigned char hwloc_topology_cpupbind_support::get_proc_cpupbind

Getting the binding of a whole given process is supported.

15.12.2.2 unsigned char hwloc_topology_cpupbind_support::get_proc_last_cpu_location

Getting the last processors where a whole process ran is supported

15.12.2.3 unsigned char hwloc_topology_cpupbind_support::get_thisproc_cpupbind

Getting the binding of the whole current process is supported.

15.12.2.4 unsigned char hwloc_topology_cpupbind_support::get_thisproc_last_cpu_location

Getting the last processors where the whole current process ran is supported

15.12.2.5 unsigned char hwloc_topology_cpupbind_support::get_thisthread_cpupbind

Getting the binding of the current thread only is supported.

15.12.2.6 unsigned char hwloc_topology_cpupbind_support::get_thisthread_last_cpu_location

Getting the last processors where the current thread ran is supported

15.12.2.7 unsigned char hwloc_topology_cpupbind_support::get_thread_cpupbind

Getting the binding of a given thread only is supported.

15.12.2.8 unsigned char hwloc_topology_cpupbind_support::set_proc_cpupbind

Binding a whole given process is supported.

15.12.2.9 unsigned char hwloc_topology_cpupbind_support::set_thisproc_cpupbind

Binding the whole current process is supported.

15.12.2.10 unsigned char hwloc_topology_cpupbind_support::set_thisthread_cpupbind

Binding the current thread only is supported.

15.12.2.11 unsigned char hwloc_topology_cpupbind_support::set_thread_cpupbind

Binding a given thread only is supported.

The documentation for this struct was generated from the following file:

- hwloc.h

15.13 hwloc_topology_discovery_support Struct Reference

```
#include <hwloc.h>
```

Data Fields

- unsigned char [pu](#)

15.13.1 Detailed Description

Flags describing actual discovery support for this topology.

15.13.2 Field Documentation

15.13.2.1 unsigned char hwloc_topology_discovery_support::pu

Detecting the number of PU objects is supported.

The documentation for this struct was generated from the following file:

- hwloc.h

15.14 hwloc_topology_membind_support Struct Reference

```
#include <hwloc.h>
```

Data Fields

- unsigned char [set_thisproc_membind](#)
- unsigned char [get_thisproc_membind](#)
- unsigned char [set_proc_membind](#)
- unsigned char [get_proc_membind](#)
- unsigned char [set_thisthread_membind](#)
- unsigned char [get_thisthread_membind](#)
- unsigned char [set_area_membind](#)
- unsigned char [get_area_membind](#)
- unsigned char [alloc_membind](#)
- unsigned char [firsttouch_membind](#)
- unsigned char [bind_membind](#)
- unsigned char [interleave_membind](#)
- unsigned char [replicate_membind](#)
- unsigned char [nexttouch_membind](#)
- unsigned char [migrate_membind](#)

15.14.1 Detailed Description

Flags describing actual memory binding support for this topology.

15.14.2 Field Documentation

15.14.2.1 unsigned char hwloc_topology_membind_support::alloc_membind

Allocating a bound memory area is supported.

15.14.2.2 unsigned char hwloc_topology_mbind_support::bind_mbind

Bind policy is supported.

15.14.2.3 unsigned char hwloc_topology_mbind_support::firsttouch_mbind

First-touch policy is supported.

15.14.2.4 unsigned char hwloc_topology_mbind_support::get_area_mbind

Getting the binding of a given memory area is supported.

15.14.2.5 unsigned char hwloc_topology_mbind_support::get_proc_mbind

Getting the binding of a whole given process is supported.

15.14.2.6 unsigned char hwloc_topology_mbind_support::get_thisproc_mbind

Getting the binding of the whole current process is supported.

15.14.2.7 unsigned char hwloc_topology_mbind_support::get_thisthread_mbind

Getting the binding of the current thread only is supported.

15.14.2.8 unsigned char hwloc_topology_mbind_support::interleave_mbind

Interleave policy is supported.

15.14.2.9 unsigned char hwloc_topology_mbind_support::migrate_mbind

Migration flags is supported.

15.14.2.10 unsigned char hwloc_topology_mbind_support::nexttouch_mbind

Next-touch migration policy is supported.

15.14.2.11 unsigned char hwloc_topology_mbind_support::replicate_mbind

Replication policy is supported.

15.14.2.12 unsigned char hwloc_topology_mbind_support::set_area_mbind

Binding a given memory area is supported.

15.14.2.13 `unsigned char hwloc_topology_membind_support::set_proc_membind`

Binding a whole given process is supported.

15.14.2.14 `unsigned char hwloc_topology_membind_support::set_thisproc_membind`

Binding the whole current process is supported.

15.14.2.15 `unsigned char hwloc_topology_membind_support::set_thisthread_membind`

Binding the current thread only is supported.

The documentation for this struct was generated from the following file:

- `hwloc.h`

15.15 `hwloc_topology_support` Struct Reference

```
#include <hwloc.h>
```

Data Fields

- struct `hwloc_topology_discovery_support * discovery`
- struct `hwloc_topology_cpubind_support * cpubind`
- struct `hwloc_topology_membind_support * membind`

15.15.1 Detailed Description

Set of flags describing actual support for this topology.

This is retrieved with `hwloc_topology_get_support()` and will be valid until the topology object is destroyed. Note: the values are correct only after discovery.

15.15.2 Field Documentation

15.15.2.1 `struct hwloc_topology_cpubind_support* hwloc_topology_support::cpubind`

15.15.2.2 `struct hwloc_topology_discovery_support* hwloc_topology_support::discovery`

15.15.2.3 `struct hwloc_topology_membind_support* hwloc_topology_support::membind`

The documentation for this struct was generated from the following file:

- `hwloc.h`

Index

- API version, [49](#)
 - [HWLOC_API_VERSION](#), [49](#)
 - [hwloc_get_api_version](#), [49](#)
- Advanced I/O object traversal helpers, [102](#)
 - [hwloc_bridge_covers_pcibus](#), [102](#)
 - [hwloc_get_hostbridge_by_pcibus](#), [102](#)
 - [hwloc_get_next_bridge](#), [102](#)
 - [hwloc_get_next_osdev](#), [102](#)
 - [hwloc_get_next_pcidev](#), [102](#)
 - [hwloc_get_non_io_ancestor_obj](#), [103](#)
 - [hwloc_get_pcidev_by_busid](#), [103](#)
 - [hwloc_get_pcidev_by_busidstring](#), [103](#)
- Advanced Traversal Helpers, [91](#)
 - [hwloc_get_closest_objs](#), [91](#)
 - [hwloc_get_obj_below_array_by_type](#), [91](#)
 - [hwloc_get_obj_below_by_type](#), [91](#)
- [alloc_membind](#)
 - [hwloc_topology_membind_support](#), [138](#)
- [allowed_cpuset](#)
 - [hwloc_obj](#), [127](#)
- [allowed_nodeset](#)
 - [hwloc_obj](#), [127](#)
- [arity](#)
 - [hwloc_obj](#), [128](#)
- [associativity](#)
 - [hwloc_obj_attr_u::hwloc_cache_attr_s](#), [124](#)
- [attr](#)
 - [hwloc_obj](#), [128](#)
- Basic Traversal Helpers, [84](#)
 - [hwloc_get_ancestor_obj_by_depth](#), [84](#)
 - [hwloc_get_ancestor_obj_by_type](#), [84](#)
 - [hwloc_get_common_ancestor_obj](#), [84](#)
 - [hwloc_get_next_child](#), [84](#)
 - [hwloc_get_next_obj_by_depth](#), [84](#)
 - [hwloc_get_next_obj_by_type](#), [85](#)
 - [hwloc_get_pu_obj_by_os_index](#), [85](#)
 - [hwloc_get_root_obj](#), [85](#)
 - [hwloc_obj_is_in_subtree](#), [85](#)
- [bind_membind](#)
 - [hwloc_topology_membind_support](#), [138](#)
- Binding Helpers, [93](#)
 - [hwloc_alloc_membind_policy](#), [93](#)
 - [hwloc_alloc_membind_policy_nodeset](#), [93](#)
 - [hwloc_distribute](#), [93](#)
 - [hwloc_distributev](#), [93](#)
- [bridge](#)
 - [hwloc_obj_attr_u](#), [132](#)
- [bus](#)
 - [hwloc_obj_attr_u::hwloc_pcidev_attr_s](#), [135](#)
- CPU binding
 - [HWLOC_CPUBIND_NOMEMBIND](#), [72](#)
 - [HWLOC_CPUBIND_PROCESS](#), [72](#)
 - [HWLOC_CPUBIND_STRICT](#), [72](#)
 - [HWLOC_CPUBIND_THREAD](#), [72](#)
- CPU binding, [71](#)
 - [hwloc_cpубind_flags_t](#), [72](#)
 - [hwloc_get_cpубind](#), [72](#)
 - [hwloc_get_last_cpu_location](#), [72](#)
 - [hwloc_get_proc_cpубind](#), [72](#)
 - [hwloc_get_proc_last_cpu_location](#), [73](#)
 - [hwloc_get_thread_cpубind](#), [73](#)
 - [hwloc_set_cpубind](#), [73](#)
 - [hwloc_set_proc_cpубind](#), [73](#)
 - [hwloc_set_thread_cpубind](#), [74](#)
- CUDA Driver API Specific Functions, [119](#)
 - [hwloc_cuda_get_device_cpuset](#), [119](#)
- CUDA Runtime API Specific Functions, [120](#)
 - [hwloc_cudart_get_device_cpuset](#), [120](#)
- [cache](#)
 - [hwloc_obj_attr_u](#), [132](#)
- Cache-specific Finding Helpers, [90](#)
 - [hwloc_get_cache_covering_cpuset](#), [90](#)
 - [hwloc_get_shared_cache_covering_obj](#), [90](#)
- [children](#)
 - [hwloc_obj](#), [128](#)
- [class_id](#)
 - [hwloc_obj_attr_u::hwloc_pcidev_attr_s](#), [135](#)
- [complete_cpuset](#)
 - [hwloc_obj](#), [128](#)
- [complete_nodeset](#)
 - [hwloc_obj](#), [128](#)
- Configure Topology Detection, [58](#)
 - [HWLOC_TOPOLOGY_FLAG_IO_BRIDGES](#), [59](#)
 - [HWLOC_TOPOLOGY_FLAG_IO_DEVICES](#), [59](#)
 - [HWLOC_TOPOLOGY_FLAG_IS_THISSYSTEM](#), [59](#)
 - [HWLOC_TOPOLOGY_FLAG_WHOLE_IO](#), [59](#)
 - [HWLOC_TOPOLOGY_FLAG_WHOLE_SYSTEM](#), [59](#)
 - [hwloc_topology_flags_e](#), [59](#)
 - [hwloc_topology_get_support](#), [59](#)

- hwloc_topology_ignore_all_keep_structure, 59
- hwloc_topology_ignore_type, 59
- hwloc_topology_ignore_type_keep_structure, 59
- hwloc_topology_set_distance_matrix, 60
- hwloc_topology_set_flags, 60
- hwloc_topology_set_fsroot, 60
- hwloc_topology_set_pid, 60
- hwloc_topology_set_synthetic, 61
- hwloc_topology_set_xml, 61
- hwloc_topology_set_xmlbuffer, 61
- Conversion between cpuset and nodeset, 98
 - hwloc_cpuset_from_nodeset, 98
 - hwloc_cpuset_from_nodeset_strict, 98
 - hwloc_cpuset_to_nodeset, 98
 - hwloc_cpuset_to_nodeset_strict, 98
- count
 - hwloc_obj_memory_s::hwloc_obj_memory_page_type_s, 133
- cpubind
 - hwloc_topology_support, 140
- cpuset
 - hwloc_obj, 128
- Cpuset Helpers, 94
 - hwloc_topology_get_allowed_cpuset, 94
 - hwloc_topology_get_complete_cpuset, 94
 - hwloc_topology_get_online_cpuset, 94
 - hwloc_topology_get_topology_cpuset, 95
- Create and Destroy Topologies, 56
 - hwloc_topology_check, 56
 - hwloc_topology_destroy, 56
 - hwloc_topology_init, 56
 - hwloc_topology_load, 56
- depth
 - hwloc_obj, 129
 - hwloc_obj_attr_u::hwloc_bridge_attr_s, 123
 - hwloc_obj_attr_u::hwloc_cache_attr_s, 124
 - hwloc_obj_attr_u::hwloc_group_attr_s, 126
- dev
 - hwloc_obj_attr_u::hwloc_pcidev_attr_s, 135
- device_id
 - hwloc_obj_attr_u::hwloc_pcidev_attr_s, 135
- discovery
 - hwloc_topology_support, 140
- Distances, 100
 - hwloc_get_distance_matrix_covering_obj_by_depth, 100
 - hwloc_get_latency, 100
 - hwloc_get_whole_distance_matrix_by_depth, 100
 - hwloc_get_whole_distance_matrix_by_type, 101
- distances
 - hwloc_obj, 129
- distances_count
 - hwloc_obj, 129
- domain
 - hwloc_obj_attr_u::hwloc_bridge_attr_s, 123
 - hwloc_obj_attr_u::hwloc_pcidev_attr_s, 135
- downstream
 - hwloc_obj_attr_u::hwloc_bridge_attr_s, 123
- downstream_type
 - hwloc_obj_attr_u::hwloc_bridge_attr_s, 123
- Finding a set of similar Objects covering at least a CPU set, 89
 - hwloc_get_next_obj_covering_cpuset_by_depth, 89
 - hwloc_get_next_obj_covering_cpuset_by_type, 89
- Finding a single Object covering at least CPU set, 88
 - hwloc_get_child_covering_cpuset, 88
 - hwloc_get_obj_covering_cpuset, 88
- Finding Objects Inside a CPU set, 86
 - hwloc_get_first_largest_obj_inside_cpuset, 86
 - hwloc_get_largest_objs_inside_cpuset, 86
 - hwloc_get_nbobjs_inside_cpuset_by_depth, 86
 - hwloc_get_nbobjs_inside_cpuset_by_type, 86
 - hwloc_get_next_obj_inside_cpuset_by_depth, 87
 - hwloc_get_next_obj_inside_cpuset_by_type, 87
 - hwloc_get_obj_inside_cpuset_by_depth, 87
 - hwloc_get_obj_inside_cpuset_by_type, 87
- first_child
 - hwloc_obj, 129
- firsttouch_membind
 - hwloc_topology_membind_support, 139
- func
 - hwloc_obj_attr_u::hwloc_pcidev_attr_s, 135
- Get Some Topology Information, 65
 - HWLOC_TYPE_DEPTH_BRIDGE, 65
 - HWLOC_TYPE_DEPTH_MULTIPLE, 65
 - HWLOC_TYPE_DEPTH_OS_DEVICE, 65
 - HWLOC_TYPE_DEPTH_PCI_DEVICE, 65
 - HWLOC_TYPE_DEPTH_UNKNOWN, 65
 - hwloc_get_depth_type, 65
 - hwloc_get_nbobjs_by_depth, 65
 - hwloc_get_nbobjs_by_type, 66
 - hwloc_get_type_depth, 66
 - hwloc_get_type_depth_e, 65
 - hwloc_topology_get_depth, 66
 - hwloc_topology_is_thissystem, 66
- get_area_membind
 - hwloc_topology_membind_support, 139
- get_proc_cpusubind
 - hwloc_topology_cpusubind_support, 136
- get_proc_last_cpu_location
 - hwloc_topology_cpusubind_support, 136
- get_proc_membind
 - hwloc_topology_membind_support, 139
- get_thisproc_cpusubind
 - hwloc_topology_cpusubind_support, 136
- get_thisproc_last_cpu_location

- hwloc_topology_cpupbind_support, [136](#)
- get_thisproc_membind
 - hwloc_topology_membind_support, [139](#)
- get_thisthread_cpupbind
 - hwloc_topology_cpupbind_support, [137](#)
- get_thisthread_last_cpu_location
 - hwloc_topology_cpupbind_support, [137](#)
- get_thisthread_membind
 - hwloc_topology_membind_support, [139](#)
- get_thread_cpupbind
 - hwloc_topology_cpupbind_support, [137](#)
- group
 - hwloc_obj_attr_u, [132](#)

- HWLOC_CPUBIND_NOMEMBIND
 - CPU binding, [72](#)
- HWLOC_CPUBIND_PROCESS
 - CPU binding, [72](#)
- HWLOC_CPUBIND_STRICT
 - CPU binding, [72](#)
- HWLOC_CPUBIND_THREAD
 - CPU binding, [72](#)
- HWLOC_MEMBIND_BIND
 - Memory binding, [77](#)
- HWLOC_MEMBIND_DEFAULT
 - Memory binding, [77](#)
- HWLOC_MEMBIND_FIRSTTOUCH
 - Memory binding, [77](#)
- HWLOC_MEMBIND_INTERLEAVE
 - Memory binding, [77](#)
- HWLOC_MEMBIND_MIGRATE
 - Memory binding, [76](#)
- HWLOC_MEMBIND_MIXED
 - Memory binding, [77](#)
- HWLOC_MEMBIND_NEXTTOUCH
 - Memory binding, [77](#)
- HWLOC_MEMBIND_NOCPUBIND
 - Memory binding, [76](#)
- HWLOC_MEMBIND_PROCESS
 - Memory binding, [76](#)
- HWLOC_MEMBIND_REPLICATE
 - Memory binding, [77](#)
- HWLOC_MEMBIND_STRICT
 - Memory binding, [76](#)
- HWLOC_MEMBIND_THREAD
 - Memory binding, [76](#)
- HWLOC_OBJ_BRIDGE
 - Topology Object Types, [54](#)
- HWLOC_OBJ_BRIDGE_HOST
 - Topology Object Types, [53](#)
- HWLOC_OBJ_BRIDGE_PCI
 - Topology Object Types, [53](#)
- HWLOC_OBJ_CACHE
 - Topology Object Types, [53](#)
- HWLOC_OBJ_CORE
 - Topology Object Types, [53](#)
- HWLOC_OBJ_GROUP
 - Topology Object Types, [53](#)
- HWLOC_OBJ_MACHINE
 - Topology Object Types, [53](#)
- HWLOC_OBJ_MISC
 - Topology Object Types, [54](#)
- HWLOC_OBJ_NODE
 - Topology Object Types, [53](#)
- HWLOC_OBJ_OS_DEVICE
 - Topology Object Types, [54](#)
- HWLOC_OBJ_OSDEV_BLOCK
 - Topology Object Types, [53](#)
- HWLOC_OBJ_OSDEV_DMA
 - Topology Object Types, [53](#)
- HWLOC_OBJ_OSDEV_GPU
 - Topology Object Types, [53](#)
- HWLOC_OBJ_OSDEV_NETWORK
 - Topology Object Types, [53](#)
- HWLOC_OBJ_OSDEV_OPENFABRICS
 - Topology Object Types, [53](#)
- HWLOC_OBJ_PCI_DEVICE
 - Topology Object Types, [54](#)
- HWLOC_OBJ_PU
 - Topology Object Types, [53](#)
- HWLOC_OBJ_SOCKET
 - Topology Object Types, [53](#)
- HWLOC_OBJ_SYSTEM
 - Topology Object Types, [53](#)
- HWLOC_OBJ_TYPE_MAX
 - Topology Object Types, [54](#)
- HWLOC_RESTRICT_FLAG_ADAPT_DISTANCES
 - Tinker With Topologies., [62](#)
- HWLOC_RESTRICT_FLAG_ADAPT_IO
 - Tinker With Topologies., [62](#)
- HWLOC_RESTRICT_FLAG_ADAPT_MISC
 - Tinker With Topologies., [62](#)
- HWLOC_TOPOLOGY_FLAG_IO_BRIDGES
 - Configure Topology Detection, [59](#)
- HWLOC_TOPOLOGY_FLAG_IO_DEVICES
 - Configure Topology Detection, [59](#)
- HWLOC_TOPOLOGY_FLAG_IS_THISSYSTEM
 - Configure Topology Detection, [59](#)
- HWLOC_TOPOLOGY_FLAG_WHOLE_IO
 - Configure Topology Detection, [59](#)
- HWLOC_TOPOLOGY_FLAG_WHOLE_SYSTEM
 - Configure Topology Detection, [59](#)
- HWLOC_TYPE_DEPTH_BRIDGE
 - Get Some Topology Information, [65](#)
- HWLOC_TYPE_DEPTH_MULTIPLE
 - Get Some Topology Information, [65](#)
- HWLOC_TYPE_DEPTH_OS_DEVICE
 - Get Some Topology Information, [65](#)

- HWLOC_TYPE_DEPTH_PCI_DEVICE
 - Get Some Topology Information, [65](#)
- HWLOC_TYPE_DEPTH_UNKNOWN
 - Get Some Topology Information, [65](#)
- HWLOC_TYPE_UNORDERED
 - Topology Object Types, [52](#)
- HWLOC_API_VERSION
 - API version, [49](#)
- Helpers for manipulating glibc sched affinity, [112](#)
 - hwloc_cpuset_from_glibc_sched_affinity, [112](#)
 - hwloc_cpuset_to_glibc_sched_affinity, [112](#)
- Helpers for manipulating Linux libnuma bitmask, [116](#)
 - hwloc_cpuset_from_linux_libnuma_bitmask, [116](#)
 - hwloc_cpuset_to_linux_libnuma_bitmask, [116](#)
 - hwloc_nodeset_from_linux_libnuma_bitmask, [116](#)
 - hwloc_nodeset_to_linux_libnuma_bitmask, [116](#)
- Helpers for manipulating Linux libnuma nodemask_t, [118](#)
 - hwloc_cpuset_from_linux_libnuma_nodemask, [118](#)
 - hwloc_cpuset_to_linux_libnuma_nodemask, [118](#)
 - hwloc_nodeset_from_linux_libnuma_nodemask, [118](#)
 - hwloc_nodeset_to_linux_libnuma_nodemask, [118](#)
- Helpers for manipulating Linux libnuma unsigned long masks, [114](#)
 - hwloc_cpuset_from_linux_libnuma_ulong, [114](#)
 - hwloc_cpuset_to_linux_libnuma_ulong, [114](#)
 - hwloc_nodeset_from_linux_libnuma_ulong, [114](#)
 - hwloc_nodeset_to_linux_libnuma_ulong, [114](#)
- hwloc_alloc
 - Memory binding, [77](#)
- hwloc_alloc_membind
 - Memory binding, [77](#)
- hwloc_alloc_membind_nodeset
 - Memory binding, [78](#)
- hwloc_alloc_membind_policy
 - Binding Helpers, [93](#)
- hwloc_alloc_membind_policy_nodeset
 - Binding Helpers, [93](#)
- hwloc_bitmap_allbut
 - The bitmap API, [106](#)
- hwloc_bitmap_alloc
 - The bitmap API, [106](#)
- hwloc_bitmap_alloc_full
 - The bitmap API, [106](#)
- hwloc_bitmap_and
 - The bitmap API, [106](#)
- hwloc_bitmap_andnot
 - The bitmap API, [106](#)
- hwloc_bitmap_asprintf
 - The bitmap API, [106](#)
- hwloc_bitmap_clr
 - The bitmap API, [107](#)
- hwloc_bitmap_clr_range
 - The bitmap API, [107](#)
- hwloc_bitmap_compare
 - The bitmap API, [107](#)
- hwloc_bitmap_compare_first
 - The bitmap API, [107](#)
- hwloc_bitmap_copy
 - The bitmap API, [107](#)
- hwloc_bitmap_dup
 - The bitmap API, [107](#)
- hwloc_bitmap_fill
 - The bitmap API, [107](#)
- hwloc_bitmap_first
 - The bitmap API, [107](#)
- hwloc_bitmap_foreach_begin
 - The bitmap API, [105](#)
- hwloc_bitmap_foreach_end
 - The bitmap API, [105](#)
- hwloc_bitmap_free
 - The bitmap API, [107](#)
- hwloc_bitmap_from_ith_ulong
 - The bitmap API, [108](#)
- hwloc_bitmap_from_ulong
 - The bitmap API, [108](#)
- hwloc_bitmap_intersects
 - The bitmap API, [108](#)
- hwloc_bitmap_isequal
 - The bitmap API, [108](#)
- hwloc_bitmap_isfull
 - The bitmap API, [108](#)
- hwloc_bitmap_isincluded
 - The bitmap API, [108](#)
- hwloc_bitmap_isset
 - The bitmap API, [108](#)
- hwloc_bitmap_iszero
 - The bitmap API, [108](#)
- hwloc_bitmap_last
 - The bitmap API, [108](#)
- hwloc_bitmap_list_asprintf
 - The bitmap API, [108](#)
- hwloc_bitmap_list_snprintf
 - The bitmap API, [109](#)
- hwloc_bitmap_list_sscanf
 - The bitmap API, [109](#)
- hwloc_bitmap_next
 - The bitmap API, [109](#)
- hwloc_bitmap_not
 - The bitmap API, [109](#)
- hwloc_bitmap_only
 - The bitmap API, [109](#)
- hwloc_bitmap_or
 - The bitmap API, [109](#)
- hwloc_bitmap_set
 - The bitmap API, [109](#)
- hwloc_bitmap_set_ith_ulong
 - The bitmap API, [109](#)
- hwloc_bitmap_set_range

- The bitmap API, [110](#)
- hwloc_bitmap_singlify
 - The bitmap API, [110](#)
- hwloc_bitmap_sprintf
 - The bitmap API, [110](#)
- hwloc_bitmap_sscanf
 - The bitmap API, [110](#)
- hwloc_bitmap_t
 - The bitmap API, [106](#)
- hwloc_bitmap_taskset_asprintf
 - The bitmap API, [110](#)
- hwloc_bitmap_taskset_sprintf
 - The bitmap API, [110](#)
- hwloc_bitmap_taskset_sscanf
 - The bitmap API, [111](#)
- hwloc_bitmap_to_ith_ulong
 - The bitmap API, [111](#)
- hwloc_bitmap_to_ulong
 - The bitmap API, [111](#)
- hwloc_bitmap_weight
 - The bitmap API, [111](#)
- hwloc_bitmap_xor
 - The bitmap API, [111](#)
- hwloc_bitmap_zero
 - The bitmap API, [111](#)
- hwloc_bridge_covers_pcibus
 - Advanced I/O object traversal helpers, [102](#)
- hwloc_compare_types
 - Topology Object Types, [54](#)
- hwloc_compare_types_e
 - Topology Object Types, [52](#)
- hwloc_const_bitmap_t
 - The bitmap API, [106](#)
- hwloc_const_cpuset_t
 - Object sets (hwloc_cpuset_t and hwloc_nodeset_t), [51](#)
- hwloc_const_nodeset_t
 - Object sets (hwloc_cpuset_t and hwloc_nodeset_t), [51](#)
- hwloc_cpubind_flags_t
 - CPU binding, [72](#)
- hwloc_cpuset_from_glibc_sched_affinity
 - Helpers for manipulating glibc sched affinity, [112](#)
- hwloc_cpuset_from_linux_libnuma_bitmask
 - Helpers for manipulating Linux libnuma bitmask, [116](#)
- hwloc_cpuset_from_linux_libnuma_nodemask
 - Helpers for manipulating Linux libnuma nodemask_t, [118](#)
- hwloc_cpuset_from_linux_libnuma_ulong
 - Helpers for manipulating Linux libnuma unsigned long masks, [114](#)
- hwloc_cpuset_from_nodeset
 - Conversion between cpuset and nodeset, [98](#)
- hwloc_cpuset_from_nodeset_strict
 - Conversion between cpuset and nodeset, [98](#)
- hwloc_cpuset_t
 - Object sets (hwloc_cpuset_t and hwloc_nodeset_t), [51](#)
- hwloc_cpuset_to_glibc_sched_affinity
 - Helpers for manipulating glibc sched affinity, [112](#)
- hwloc_cpuset_to_linux_libnuma_bitmask
 - Helpers for manipulating Linux libnuma bitmask, [116](#)
- hwloc_cpuset_to_linux_libnuma_nodemask
 - Helpers for manipulating Linux libnuma nodemask_t, [118](#)
- hwloc_cpuset_to_linux_libnuma_ulong
 - Helpers for manipulating Linux libnuma unsigned long masks, [114](#)
- hwloc_cpuset_to_nodeset
 - Conversion between cpuset and nodeset, [98](#)
- hwloc_cpuset_to_nodeset_strict
 - Conversion between cpuset and nodeset, [98](#)
- hwloc_cuda_get_device_cpuset
 - CUDA Driver API Specific Functions, [119](#)
- hwloc_cudart_get_device_cpuset
 - CUDA Runtime API Specific Functions, [120](#)
- hwloc_distances_s, [125](#)
 - latency, [125](#)
 - latency_base, [125](#)
 - latency_max, [125](#)
 - nbobjs, [125](#)
 - relative_depth, [126](#)
- hwloc_distribute
 - Binding Helpers, [93](#)
- hwloc_distributev
 - Binding Helpers, [93](#)
- hwloc_free
 - Memory binding, [78](#)
- hwloc_free_xmlbuffer
 - Tinker With Topologies., [62](#)
- hwloc_get_ancestor_obj_by_depth
 - Basic Traversal Helpers, [84](#)
- hwloc_get_ancestor_obj_by_type
 - Basic Traversal Helpers, [84](#)
- hwloc_get_api_version
 - API version, [49](#)
- hwloc_get_area_membind
 - Memory binding, [78](#)
- hwloc_get_area_membind_nodeset
 - Memory binding, [78](#)
- hwloc_get_cache_covering_cpuset
 - Cache-specific Finding Helpers, [90](#)
- hwloc_get_child_covering_cpuset
 - Finding a single Object covering at least CPU set, [88](#)
- hwloc_get_closest_objs
 - Advanced Traversal Helpers, [91](#)
- hwloc_get_common_ancestor_obj
 - Basic Traversal Helpers, [84](#)

- hwloc_get_cpubind
 - CPU binding, [72](#)
- hwloc_get_depth_type
 - Get Some Topology Information, [65](#)
- hwloc_get_distance_matrix_covering_obj_by_depth
 - Distances, [100](#)
- hwloc_get_first_largest_obj_inside_cpuset
 - Finding Objects Inside a CPU set, [86](#)
- hwloc_get_hostbridge_by_pcibus
 - Advanced I/O object traversal helpers, [102](#)
- hwloc_get_largest_objs_inside_cpuset
 - Finding Objects Inside a CPU set, [86](#)
- hwloc_get_last_cpu_location
 - CPU binding, [72](#)
- hwloc_get_latency
 - Distances, [100](#)
- hwloc_get_membind
 - Memory binding, [79](#)
- hwloc_get_membind_noderset
 - Memory binding, [79](#)
- hwloc_get_nbobjs_by_depth
 - Get Some Topology Information, [65](#)
- hwloc_get_nbobjs_by_type
 - Get Some Topology Information, [66](#)
- hwloc_get_nbobjs_inside_cpuset_by_depth
 - Finding Objects Inside a CPU set, [86](#)
- hwloc_get_nbobjs_inside_cpuset_by_type
 - Finding Objects Inside a CPU set, [86](#)
- hwloc_get_next_bridge
 - Advanced I/O object traversal helpers, [102](#)
- hwloc_get_next_child
 - Basic Traversal Helpers, [84](#)
- hwloc_get_next_obj_by_depth
 - Basic Traversal Helpers, [84](#)
- hwloc_get_next_obj_by_type
 - Basic Traversal Helpers, [85](#)
- hwloc_get_next_obj_covering_cpuset_by_depth
 - Finding a set of similar Objects covering at least a C-PU set, [89](#)
- hwloc_get_next_obj_covering_cpuset_by_type
 - Finding a set of similar Objects covering at least a C-PU set, [89](#)
- hwloc_get_next_obj_inside_cpuset_by_depth
 - Finding Objects Inside a CPU set, [87](#)
- hwloc_get_next_obj_inside_cpuset_by_type
 - Finding Objects Inside a CPU set, [87](#)
- hwloc_get_next_osdev
 - Advanced I/O object traversal helpers, [102](#)
- hwloc_get_next_pcidev
 - Advanced I/O object traversal helpers, [102](#)
- hwloc_get_non_io_ancestor_obj
 - Advanced I/O object traversal helpers, [103](#)
- hwloc_get_obj_below_array_by_type
 - Advanced Traversal Helpers, [91](#)
- hwloc_get_obj_below_by_type
 - Advanced Traversal Helpers, [91](#)
- hwloc_get_obj_by_depth
 - Retrieve Objects, [67](#)
- hwloc_get_obj_by_type
 - Retrieve Objects, [67](#)
- hwloc_get_obj_covering_cpuset
 - Finding a single Object covering at least CPU set, [88](#)
- hwloc_get_obj_inside_cpuset_by_depth
 - Finding Objects Inside a CPU set, [87](#)
- hwloc_get_obj_inside_cpuset_by_type
 - Finding Objects Inside a CPU set, [87](#)
- hwloc_get_pcidev_by_busid
 - Advanced I/O object traversal helpers, [103](#)
- hwloc_get_pcidev_by_busidstring
 - Advanced I/O object traversal helpers, [103](#)
- hwloc_get_proc_cpubind
 - CPU binding, [72](#)
- hwloc_get_proc_last_cpu_location
 - CPU binding, [73](#)
- hwloc_get_proc_membind
 - Memory binding, [80](#)
- hwloc_get_proc_membind_noderset
 - Memory binding, [80](#)
- hwloc_get_pu_obj_by_os_index
 - Basic Traversal Helpers, [85](#)
- hwloc_get_root_obj
 - Basic Traversal Helpers, [85](#)
- hwloc_get_shared_cache_covering_obj
 - Cache-specific Finding Helpers, [90](#)
- hwloc_get_thread_cpubind
 - CPU binding, [73](#)
- hwloc_get_type_depth
 - Get Some Topology Information, [66](#)
- hwloc_get_type_depth_e
 - Get Some Topology Information, [65](#)
- hwloc_get_type_or_above_depth
 - Object Type Helpers, [83](#)
- hwloc_get_type_or_below_depth
 - Object Type Helpers, [83](#)
- hwloc_get_whole_distance_matrix_by_depth
 - Distances, [100](#)
- hwloc_get_whole_distance_matrix_by_type
 - Distances, [101](#)
- hwloc_ibv_get_device_cpuset
 - OpenFabrics-Specific Functions, [121](#)
- hwloc_linux_get_tid_cpubind
 - Linux-only helpers, [113](#)
- hwloc_linux_parse_cpumap_file
 - Linux-only helpers, [113](#)
- hwloc_linux_set_tid_cpubind
 - Linux-only helpers, [113](#)
- hwloc_membind_flags_t
 - Memory binding, [76](#)

- hwloc_membind_policy_t
 - Memory binding, 77
- hwloc_mx_board_get_device_cpuset
 - Myrinet Express-Specific Functions, 122
- hwloc_mx_endpoint_get_device_cpuset
 - Myrinet Express-Specific Functions, 122
- hwloc_nodeseq_from_linux_libnuma_bitmask
 - Helpers for manipulating Linux libnuma bitmask, 116
- hwloc_nodeseq_from_linux_libnuma_nodemask
 - Helpers for manipulating Linux libnuma nodemask_t, 118
- hwloc_nodeseq_from_linux_libnuma_ulong
 - Helpers for manipulating Linux libnuma unsigned long masks, 114
- hwloc_nodeseq_t
 - Object sets (hwloc_cpuset_t and hwloc_nodeseq_t), 51
- hwloc_nodeseq_to_linux_libnuma_bitmask
 - Helpers for manipulating Linux libnuma bitmask, 116
- hwloc_nodeseq_to_linux_libnuma_nodemask
 - Helpers for manipulating Linux libnuma nodemask_t, 118
- hwloc_nodeseq_to_linux_libnuma_ulong
 - Helpers for manipulating Linux libnuma unsigned long masks, 114
- hwloc_obj, 126
 - allowed_cpuset, 127
 - allowed_nodeseq, 127
 - arity, 128
 - attr, 128
 - children, 128
 - complete_cpuset, 128
 - complete_nodeseq, 128
 - cpuset, 128
 - depth, 129
 - distances, 129
 - distances_count, 129
 - first_child, 129
 - infos, 129
 - infos_count, 129
 - last_child, 129
 - logical_index, 129
 - memory, 129
 - name, 129
 - next_cousin, 130
 - next_sibling, 130
 - nodeseq, 130
 - online_cpuset, 130
 - os_index, 130
 - os_level, 130
 - parent, 130
 - prev_cousin, 131
 - prev_sibling, 131
 - sibling_rank, 131
 - type, 131
 - userdata, 131
- hwloc_obj_add_info
 - Object/String Conversion, 68
- hwloc_obj_attr_snprintf
 - Object/String Conversion, 68
- hwloc_obj_attr_u, 131
 - bridge, 132
 - cache, 132
 - group, 132
 - osdev, 132
 - pcidev, 132
- hwloc_obj_attr_u::hwloc_bridge_attr_s, 123
 - depth, 123
 - domain, 123
 - downstream, 123
 - downstream_type, 123
 - pci, 124
 - secondary_bus, 124
 - subordinate_bus, 124
 - upstream, 124
 - upstream_type, 124
- hwloc_obj_attr_u::hwloc_cache_attr_s, 124
 - associativity, 124
 - depth, 124
 - linesize, 124
 - size, 124
- hwloc_obj_attr_u::hwloc_group_attr_s, 126
 - depth, 126
- hwloc_obj_attr_u::hwloc_osdev_attr_s, 134
 - type, 135
- hwloc_obj_attr_u::hwloc_pcidev_attr_s, 135
 - bus, 135
 - class_id, 135
 - dev, 135
 - device_id, 135
 - domain, 135
 - func, 135
 - linkspeed, 135
 - revision, 135
 - subdevice_id, 135
 - subvendor_id, 136
 - vendor_id, 136
- hwloc_obj_bridge_type_e
 - Topology Object Types, 52
- hwloc_obj_bridge_type_t
 - Topology Object Types, 52
- hwloc_obj_cpuset_snprintf
 - Object/String Conversion, 68
- hwloc_obj_get_info_by_name
 - Object/String Conversion, 69
- hwloc_obj_info_s, 132
 - name, 132
 - value, 132

- hwloc_obj_is_in_subtree
 - Basic Traversal Helpers, [85](#)
- hwloc_obj_memory_s, [133](#)
 - local_memory, [134](#)
 - page_types, [134](#)
 - page_types_len, [134](#)
 - total_memory, [134](#)
- hwloc_obj_memory_s::hwloc_obj_memory_page_type_s, [133](#)
 - count, [133](#)
 - size, [133](#)
- hwloc_obj_osdev_type_e
 - Topology Object Types, [53](#)
- hwloc_obj_osdev_type_t
 - Topology Object Types, [52](#)
- hwloc_obj_snprintf
 - Object/String Conversion, [69](#)
- hwloc_obj_t
 - Topology Objects, [55](#)
- hwloc_obj_type_of_string
 - Object/String Conversion, [69](#)
- hwloc_obj_type_snprintf
 - Object/String Conversion, [69](#)
- hwloc_obj_type_string
 - Object/String Conversion, [70](#)
- hwloc_obj_type_t
 - Topology Object Types, [53](#)
- hwloc_restrict_flags_e
 - Tinker With Topologies., [62](#)
- hwloc_set_area_membind
 - Memory binding, [81](#)
- hwloc_set_area_membind_nodest
 - Memory binding, [81](#)
- hwloc_set_cpupbind
 - CPU binding, [73](#)
- hwloc_set_membind
 - Memory binding, [81](#)
- hwloc_set_membind_nodest
 - Memory binding, [81](#)
- hwloc_set_proc_cpupbind
 - CPU binding, [73](#)
- hwloc_set_proc_membind
 - Memory binding, [82](#)
- hwloc_set_proc_membind_nodest
 - Memory binding, [82](#)
- hwloc_set_thread_cpupbind
 - CPU binding, [74](#)
- hwloc_topology_check
 - Create and Destroy Topologies, [56](#)
- hwloc_topology_cpupbind_support, [136](#)
 - get_proc_cpupbind, [136](#)
 - get_proc_last_cpu_location, [136](#)
 - get_thisproc_cpupbind, [136](#)
 - get_thisproc_last_cpu_location, [136](#)
- get_thisthread_cpupbind, [137](#)
- get_thisthread_last_cpu_location, [137](#)
- get_thread_cpupbind, [137](#)
- set_proc_cpupbind, [137](#)
- set_thisproc_cpupbind, [137](#)
- set_thisthread_cpupbind, [137](#)
- set_thread_cpupbind, [137](#)
- hwloc_topology_destroy
 - Create and Destroy Topologies, [56](#)
- hwloc_topology_discovery_support, [137](#)
 - pu, [138](#)
- hwloc_topology_export_xml
 - Tinker With Topologies., [62](#)
- hwloc_topology_export_xmlbuffer
 - Tinker With Topologies., [63](#)
- hwloc_topology_flags_e
 - Configure Topology Detection, [59](#)
- hwloc_topology_get_allowed_cpupset
 - Cpupset Helpers, [94](#)
- hwloc_topology_get_allowed_nodest
 - Nodest Helpers, [96](#)
- hwloc_topology_get_complete_cpupset
 - Cpupset Helpers, [94](#)
- hwloc_topology_get_complete_nodest
 - Nodest Helpers, [96](#)
- hwloc_topology_get_depth
 - Get Some Topology Information, [66](#)
- hwloc_topology_get_online_cpupset
 - Cpupset Helpers, [94](#)
- hwloc_topology_get_support
 - Configure Topology Detection, [59](#)
- hwloc_topology_get_topology_cpupset
 - Cpupset Helpers, [95](#)
- hwloc_topology_get_topology_nodest
 - Nodest Helpers, [96](#)
- hwloc_topology_ignore_all_keep_structure
 - Configure Topology Detection, [59](#)
- hwloc_topology_ignore_type
 - Configure Topology Detection, [59](#)
- hwloc_topology_ignore_type_keep_structure
 - Configure Topology Detection, [59](#)
- hwloc_topology_init
 - Create and Destroy Topologies, [56](#)
- hwloc_topology_insert_misc_object_by_cpupset
 - Tinker With Topologies., [63](#)
- hwloc_topology_insert_misc_object_by_parent
 - Tinker With Topologies., [63](#)
- hwloc_topology_is_thissystem
 - Get Some Topology Information, [66](#)
- hwloc_topology_load
 - Create and Destroy Topologies, [56](#)
- hwloc_topology_membind_support, [138](#)
 - alloc_membind, [138](#)
 - bind_membind, [138](#)

- firsttouch_membind, [139](#)
- get_area_membind, [139](#)
- get_proc_membind, [139](#)
- get_thisproc_membind, [139](#)
- get_thisthread_membind, [139](#)
- interleave_membind, [139](#)
- migrate_membind, [139](#)
- nexttouch_membind, [139](#)
- replicate_membind, [139](#)
- set_area_membind, [139](#)
- set_proc_membind, [139](#)
- set_thisproc_membind, [140](#)
- set_thisthread_membind, [140](#)
- hwloc_topology_restrict
 - Tinker With Topologies., [63](#)
- hwloc_topology_set_distance_matrix
 - Configure Topology Detection, [60](#)
- hwloc_topology_set_flags
 - Configure Topology Detection, [60](#)
- hwloc_topology_set_fsroot
 - Configure Topology Detection, [60](#)
- hwloc_topology_set_pid
 - Configure Topology Detection, [60](#)
- hwloc_topology_set_synthetic
 - Configure Topology Detection, [61](#)
- hwloc_topology_set_xml
 - Configure Topology Detection, [61](#)
- hwloc_topology_set_xmlbuffer
 - Configure Topology Detection, [61](#)
- hwloc_topology_support, [140](#)
 - cpubind, [140](#)
 - discovery, [140](#)
 - membind, [140](#)
- hwloc_topology_t
 - Topology context, [50](#)
- infos
 - hwloc_obj, [129](#)
- infos_count
 - hwloc_obj, [129](#)
- interleave_membind
 - hwloc_topology_membind_support, [139](#)
- last_child
 - hwloc_obj, [129](#)
- latency
 - hwloc_distances_s, [125](#)
- latency_base
 - hwloc_distances_s, [125](#)
- latency_max
 - hwloc_distances_s, [125](#)
- linesize
 - hwloc_obj_attr_u::hwloc_cache_attr_s, [124](#)
- linkspeed
 - hwloc_obj_attr_u::hwloc_pciddev_attr_s, [135](#)
- Linux-only helpers, [113](#)
 - hwloc_linux_get_tid_cpusbind, [113](#)
 - hwloc_linux_parse_cpumap_file, [113](#)
 - hwloc_linux_set_tid_cpusbind, [113](#)
- local_memory
 - hwloc_obj_memory_s, [134](#)
- logical_index
 - hwloc_obj, [129](#)
- membind
 - hwloc_topology_support, [140](#)
- memory
 - hwloc_obj, [129](#)
- Memory binding, [75](#)
 - HWLOC_MEMBIND_BIND, [77](#)
 - HWLOC_MEMBIND_DEFAULT, [77](#)
 - HWLOC_MEMBIND_FIRSTTOUCH, [77](#)
 - HWLOC_MEMBIND_INTERLEAVE, [77](#)
 - HWLOC_MEMBIND_MIGRATE, [76](#)
 - HWLOC_MEMBIND_MIXED, [77](#)
 - HWLOC_MEMBIND_NEXTTOUCH, [77](#)
 - HWLOC_MEMBIND_NOCPUBIND, [76](#)
 - HWLOC_MEMBIND_PROCESS, [76](#)
 - HWLOC_MEMBIND_REPLICATE, [77](#)
 - HWLOC_MEMBIND_STRICT, [76](#)
 - HWLOC_MEMBIND_THREAD, [76](#)
 - hwloc_alloc, [77](#)
 - hwloc_alloc_membind, [77](#)
 - hwloc_alloc_membind_nodese, [78](#)
 - hwloc_free, [78](#)
 - hwloc_get_area_membind, [78](#)
 - hwloc_get_area_membind_nodese, [78](#)
 - hwloc_get_membind, [79](#)
 - hwloc_get_membind_nodese, [79](#)
 - hwloc_get_proc_membind, [80](#)
 - hwloc_get_proc_membind_nodese, [80](#)
 - hwloc_membind_flags_t, [76](#)
 - hwloc_membind_policy_t, [77](#)
 - hwloc_set_area_membind, [81](#)
 - hwloc_set_area_membind_nodese, [81](#)
 - hwloc_set_membind, [81](#)
 - hwloc_set_membind_nodese, [81](#)
 - hwloc_set_proc_membind, [82](#)
 - hwloc_set_proc_membind_nodese, [82](#)
- migrate_membind
 - hwloc_topology_membind_support, [139](#)
- Myrinet Express-Specific Functions, [122](#)
 - hwloc_mx_board_get_device_cpuset, [122](#)
 - hwloc_mx_endpoint_get_device_cpuset, [122](#)
- name
 - hwloc_obj, [129](#)
 - hwloc_obj_info_s, [132](#)
- nbobjs
 - hwloc_distances_s, [125](#)

- next_cousin
 - hwloc_obj, 130
- next_sibling
 - hwloc_obj, 130
- nexttouch_membind
 - hwloc_topology_membind_support, 139
- nodeset
 - hwloc_obj, 130
- Nodeset Helpers, 96
 - hwloc_topology_get_allowed_nodeset, 96
 - hwloc_topology_get_complete_nodeset, 96
 - hwloc_topology_get_topology_nodeset, 96
- Object sets (hwloc_cpuset_t and hwloc_nodeset_t), 51
 - hwloc_const_cpuset_t, 51
 - hwloc_const_nodeset_t, 51
 - hwloc_cpuset_t, 51
 - hwloc_nodeset_t, 51
- Object Type Helpers, 83
 - hwloc_get_type_or_above_depth, 83
 - hwloc_get_type_or_below_depth, 83
- Object/String Conversion, 68
 - hwloc_obj_add_info, 68
 - hwloc_obj_attr_snprintf, 68
 - hwloc_obj_cpuset_snprintf, 68
 - hwloc_obj_get_info_by_name, 69
 - hwloc_obj_snprintf, 69
 - hwloc_obj_type_of_string, 69
 - hwloc_obj_type_snprintf, 69
 - hwloc_obj_type_string, 70
- online_cpuset
 - hwloc_obj, 130
- OpenFabrics-Specific Functions, 121
 - hwloc_ibv_get_device_cpuset, 121
- os_index
 - hwloc_obj, 130
- os_level
 - hwloc_obj, 130
- osdev
 - hwloc_obj_attr_u, 132
- page_types
 - hwloc_obj_memory_s, 134
- page_types_len
 - hwloc_obj_memory_s, 134
- parent
 - hwloc_obj, 130
- pci
 - hwloc_obj_attr_u::hwloc_bridge_attr_s, 124
- pcidev
 - hwloc_obj_attr_u, 132
- prev_cousin
 - hwloc_obj, 131
- prev_sibling
 - hwloc_obj, 131
- pu
 - hwloc_topology_discovery_support, 138
- relative_depth
 - hwloc_distances_s, 126
- replicate_membind
 - hwloc_topology_membind_support, 139
- Retrieve Objects, 67
 - hwloc_get_obj_by_depth, 67
 - hwloc_get_obj_by_type, 67
- revision
 - hwloc_obj_attr_u::hwloc_pcidev_attr_s, 135
- secondary_bus
 - hwloc_obj_attr_u::hwloc_bridge_attr_s, 124
- set_area_membind
 - hwloc_topology_membind_support, 139
- set_proc_cpupbind
 - hwloc_topology_cpupbind_support, 137
- set_proc_membind
 - hwloc_topology_membind_support, 139
- set_thisproc_cpupbind
 - hwloc_topology_cpupbind_support, 137
- set_thisproc_membind
 - hwloc_topology_membind_support, 140
- set_thisthread_cpupbind
 - hwloc_topology_cpupbind_support, 137
- set_thisthread_membind
 - hwloc_topology_membind_support, 140
- set_thread_cpupbind
 - hwloc_topology_cpupbind_support, 137
- sibling_rank
 - hwloc_obj, 131
- size
 - hwloc_obj_attr_u::hwloc_cache_attr_s, 124
 - hwloc_obj_memory_s::hwloc_obj_memory_page_type_s, 133
- subdevice_id
 - hwloc_obj_attr_u::hwloc_pcidev_attr_s, 135
- subordinate_bus
 - hwloc_obj_attr_u::hwloc_bridge_attr_s, 124
- subvendor_id
 - hwloc_obj_attr_u::hwloc_pcidev_attr_s, 136
- The bitmap API, 104
 - hwloc_bitmap_allbut, 106
 - hwloc_bitmap_alloc, 106
 - hwloc_bitmap_alloc_full, 106
 - hwloc_bitmap_and, 106
 - hwloc_bitmap_andnot, 106
 - hwloc_bitmap_asprintf, 106
 - hwloc_bitmap_clr, 107
 - hwloc_bitmap_clr_range, 107
 - hwloc_bitmap_compare, 107
 - hwloc_bitmap_compare_first, 107

- hwloc_bitmap_copy, 107
- hwloc_bitmap_dup, 107
- hwloc_bitmap_fill, 107
- hwloc_bitmap_first, 107
- hwloc_bitmap_foreach_begin, 105
- hwloc_bitmap_foreach_end, 105
- hwloc_bitmap_free, 107
- hwloc_bitmap_from_ith_ulong, 108
- hwloc_bitmap_from_ulong, 108
- hwloc_bitmap_intersects, 108
- hwloc_bitmap_isequal, 108
- hwloc_bitmap_isfull, 108
- hwloc_bitmap_isincluded, 108
- hwloc_bitmap_isset, 108
- hwloc_bitmap_iszero, 108
- hwloc_bitmap_last, 108
- hwloc_bitmap_list_asprintf, 108
- hwloc_bitmap_list_snprintf, 109
- hwloc_bitmap_list_sscanf, 109
- hwloc_bitmap_next, 109
- hwloc_bitmap_not, 109
- hwloc_bitmap_only, 109
- hwloc_bitmap_or, 109
- hwloc_bitmap_set, 109
- hwloc_bitmap_set_ith_ulong, 109
- hwloc_bitmap_set_range, 110
- hwloc_bitmap_singlify, 110
- hwloc_bitmap_snprintf, 110
- hwloc_bitmap_sscanf, 110
- hwloc_bitmap_t, 106
- hwloc_bitmap_taskset_asprintf, 110
- hwloc_bitmap_taskset_snprintf, 110
- hwloc_bitmap_taskset_sscanf, 111
- hwloc_bitmap_to_ith_ulong, 111
- hwloc_bitmap_to_ulong, 111
- hwloc_bitmap_weight, 111
- hwloc_bitmap_xor, 111
- hwloc_bitmap_zero, 111
- hwloc_const_bitmap_t, 106
- Tinker With Topologies., 62
 - HWLOC_RESTRICT_FLAG_ADAPT_DISTANCES, 62
 - HWLOC_RESTRICT_FLAG_ADAPT_IO, 62
 - HWLOC_RESTRICT_FLAG_ADAPT_MISC, 62
 - hwloc_free_xmlbuffer, 62
 - hwloc_restrict_flags_e, 62
 - hwloc_topology_export_xml, 62
 - hwloc_topology_export_xmlbuffer, 63
 - hwloc_topology_insert_misc_object_by_cpuset, 63
 - hwloc_topology_insert_misc_object_by_parent, 63
 - hwloc_topology_restrict, 63
- Topology context, 50
 - hwloc_topology_t, 50
- Topology Object Types, 52
 - HWLOC_OBJ_BRIDGE, 54
 - HWLOC_OBJ_BRIDGE_HOST, 53
 - HWLOC_OBJ_BRIDGE_PCI, 53
 - HWLOC_OBJ_CACHE, 53
 - HWLOC_OBJ_CORE, 53
 - HWLOC_OBJ_GROUP, 53
 - HWLOC_OBJ_MACHINE, 53
 - HWLOC_OBJ_MISC, 54
 - HWLOC_OBJ_NODE, 53
 - HWLOC_OBJ_OS_DEVICE, 54
 - HWLOC_OBJ_OSDEV_BLOCK, 53
 - HWLOC_OBJ_OSDEV_DMA, 53
 - HWLOC_OBJ_OSDEV_GPU, 53
 - HWLOC_OBJ_OSDEV_NETWORK, 53
 - HWLOC_OBJ_OSDEV_OPENFABRICS, 53
 - HWLOC_OBJ_PCI_DEVICE, 54
 - HWLOC_OBJ_PU, 53
 - HWLOC_OBJ_SOCKET, 53
 - HWLOC_OBJ_SYSTEM, 53
 - HWLOC_OBJ_TYPE_MAX, 54
 - HWLOC_TYPE_UNORDERED, 52
 - hwloc_compare_types, 54
 - hwloc_compare_types_e, 52
 - hwloc_obj_bridge_type_e, 52
 - hwloc_obj_bridge_type_t, 52
 - hwloc_obj_osdev_type_e, 53
 - hwloc_obj_osdev_type_t, 52
 - hwloc_obj_type_t, 53
 - Topology Objects, 55
 - hwloc_obj_t, 55
 - total_memory
 - hwloc_obj_memory_s, 134
 - type
 - hwloc_obj, 131
 - hwloc_obj_attr_u::hwloc_osdev_attr_s, 135
 - upstream
 - hwloc_obj_attr_u::hwloc_bridge_attr_s, 124
 - upstream_type
 - hwloc_obj_attr_u::hwloc_bridge_attr_s, 124
 - userdata
 - hwloc_obj, 131
 - value
 - hwloc_obj_info_s, 132
 - vendor_id
 - hwloc_obj_attr_u::hwloc_pcidev_attr_s, 136